

PRODUCT CATALOG

BIGGER BETTER BRUSH IDEAS





OUR COMMITMENT TO YOU

At Gordon Brush we are committed to helping our customers improve their productivity and profitability by providing them with high quality brushes that fulfill their specific requirements, are priced competitively and shipped on time. Our extensive inventory and sophisticated computer management system enable us to ship the majority of our standard brushes the same day the order is received.

We hope you will find this new, expanded catalog informative and easy to use. Although it features the majority of our standard products, not all of the over 15,000 different brushes Gordon Brush manufactures are included. Please call us if what you want is not shown. If we are not already manufacturing a brush to fit your needs, our experienced engineers are at your service to help you modify or design a product to meet your precise specifications.

Our knowledgeable customer service representatives are available to answer any questions and to assist you with your order. You can reach us by phone at (800) 950-7950 or (323) 724-7777, by fax at (323) 724-1111, or by email at sales@gordonbrush.com. We also invite you to visit our website at www.gordonbrush.com.

We look forward to doing business with you.

CONTENTS

ESD Brush Information	2
Brush Terminology.....	2
Brush Fill Material	2-3
How Brushes Are Measured.....	3
Wood Handle Brushes	4
Plastic Handle Brushes	5
Aluminum/Acetal Hand Laced Brushes.....	6
Wood-Hand Laced Brushes	7
Scratch Brushes	8
Platers' Brushes	9
Block Brushes	10
Long Block, Upright and Thunderon Brushes.....	11
Dusting and Scrub Brushes	12
Acid/Sash/Parts Cleaning Brushes	13
Applicator Brushes.....	14-15
Artist/Detail Brushes.....	16-19
Flow-Thru Brushes.....	20
Vacuum/Specialty Brushes	21
Metal Channel Strip Brushes.....	22-24
Micro Spiral Brushes/Thread Cleaning Brushes.....	25
Tube or Spiral Brushes.....	26-27
Double Spiral Power Brushes.....	28
Condenser and Flue Brushes	29
Side Action/Paddle/Valve Brushes.....	30
Spiral Brushes	31
Metal Free Tube Brushes	32
Bore Brushes.....	33
Handles	34
Floor/Push Brooms	35-37
Floor Squeegees	38
Floor Squeegees	39
Upright Brooms, Deck Scrubs, and Utility Brushes.....	40
Wash Brushes, Hygienic Brushes, Bowl Brushes, and Sponge Mops	41
Janitorial eMOP, Microfiber Pads, Lobby Brooms, and Dustpans	42
Abrasives, Buffs and Rotary Scrub Brushes	43
Abrasives and Cylinder Brushes	44
Fine Finish Oil and Water Based Brushes.....	45
Fine Finish Water-Based and Disposable Brushes	46
Specialty Paint Brushes and Accessories.....	47
Roller Covers	48
Specialty Roller Covers and Mini Roller Covers	49
Roller Accessories.....	50
Index	51-52

**VISIT OUR WEB SITE AT:
www.gordonbrush.com
for more technical
information in the
engineering corner.**

**Go online for custom
brush design sheets or
call customer service
at 323-724-7777 to
have a design sheet
faxed to you.**



*Gordon Brush is located in a state-of-the-art
facility in the metropolitan area of
Los Angeles, California.*

© Copyright 2017, Gordon Brush Mfg. Co., Inc.

No part of this catalog may be reproduced
without prior written permission from
Gordon Brush Mfg. Co., Inc.

All statements, technical data, and
recommendations contained herein are based
on information that we believe to be reliable, but
the accuracy or completeness of which is not
guaranteed, and the following is made in lieu of
all warranties, express or implied:

Seller's and manufacturers only obligations shall
be to replace such quantities of the product
proved to be defective. Neither seller nor
manufacturer shall be liable for any injury, loss
or damage, direct or consequential, arising out of
the use, or inability to use, the product. Before
using, the user shall determine the suitability of
the product for his intended use, and the user
assumes all risk and liability whatsoever in
connection herewith. No statement or
recommendation contained herein shall have any
force or effect, unless in an agreement signed by
the officers of both the user and the seller.

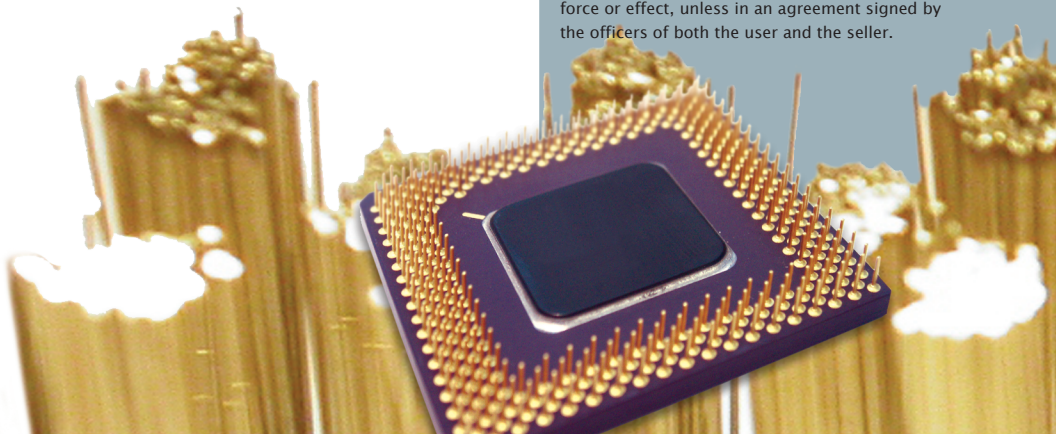

ESD BRUSHES

Static is a fairly simple but often misunderstood event. Briefly stated, a static charge is generated through friction, pressure, or separation of two dissimilar materials. This process is called the Triboelectric Effect (tribo means rubbing). Static electricity causes problems on many different surfaces, including, but not limited to, attracting and holding unwanted contaminants and other dissimilarly charged parts.

Electrostatic Discharge (ESD) is defined as the transfer of charges between materials at different electrical potentials. Problems caused by ESD range from destroying or degrading semiconductor devices to upsetting the operation of electronic systems and causing equipment failure.

ESD SYMBOLS

The following symbols are used in this catalog to indicate when a particular brush is recommended based on its specific ESD properties:

◆ Anti-Static ▲ Static Dissipative ● Conductive

HOW ESD BRUSHES ARE CLASSIFIED

The most critical aspects of a brush are the fiber and the core or handle material. Surface resistivity is a mathematical representation of a material's ability to resist the passage of electricity across its surface. The range of surface resistivity (in Ohms) is as follows:

$10^2 - 10^4$	Conductive Materials*
$10^5 - 10^{11}$	Dissipative Materials*
(see below)	Anti-Static
$10^{12} - 10^{16}$	Insulative Materials

* **Ohm's Law:** $E = I \times R$, or voltage equals current times resistance. Conductive materials have a near "0" value for R. Static dissipative materials have a very large R value. This is important because $I = E/R$. A large static charge, when grounded, results in a very large current flow in the absence of an equally large resistance.

Conductive Brushes

Conductive brushes are made with materials that have a low electrical resistance, and generally have a surface resistivity range of $10^2 - 10^4$. These brushes will easily and uniformly accept a charge and when attached to a grounding point, will provide a very rapid transfer to ground. This rapid transfer could be harmful to some electrical components.

Dissipative Brushes

Dissipative brushes are made with materials that have a surface resistivity of $10^5 - 10^{11}$, a higher resistivity than conductive brushes, but sufficiently conductive to permit controlled current flow. These brushes are excellent tools for removing static electricity, frequent use of dissipative brushes will keep electrostatic charges from building and will provide a slower, more controlled transfer to ground than a conductive brush. They are the only brushes recommended for use with Class 1 components.

Anti-Static Brushes

Anti-Static (static charge inhibitor) brushes are made from low charging and/or natural materials that are near neutral on the triboelectric chart. These brushes remain neutral because they neither give nor take electrons. However, there can be a slight

charge created. Therefore, in extremely sensitive applications, these brushes should only be used in a liquid environment. Only conductive or dissipative brushes should be used in an extremely sensitive, dry environment.

Insulative Brushes

Insulative brushes are made of materials that prevent the flow of electrons, and generally have a surface resistivity of $10^{12} - 10^{16}$. Any charge generated on the brush will remain there for an extended period of time. Insulative brushes are a less expensive alternative to anti-static brushes. They are best used in an environment where static is not critical or where the brush is submerged in a liquid when in use. Most brushes are made with non-conductive material and are insulative.

Please Note: If the brush is mounted to a non-grounded material, then a grounding strap or wire incorporating a 1 Mega Ohm resistor should be used between the brush and an electrical ground. Potentially severe bodily harm may result from the use of a conductive brush if a resistor is not used.

BRUSH TERMINOLOGY

Fill Material Size

The thickness of a single piece of wire or filament, measured in inches. Smaller diameter fill material is softer than the same fill material in a larger diameter.

Trim or Trim Length

The length of the fill material. Shorter fill material is stiffer than the same fill material in a longer trim length.

Level Fill Material

The filament or wire is straight.

Crimped Fill Material

Each strand of filament or wire is wavy, which produces a brush that is denser in appearance and provides a continuous, more even brushing action.

BRUSH FILL MATERIAL

Animal Hair

Camel Hair: Not from a camel, but a generic term used for many types of an economically priced soft hair that is commonly used for artist brushes.

Goat Hair: A very fine, soft hair that is excellent for fine polishing and cleaning.

Hog Bristle: Strong and fairly stiff, with a natural taper and a split end. It has great resilience with excellent durability and water resistance. Heat tolerant to 370°F.

Horse Hair: A durable hair that is soft to slightly stiff, used for scratch-free dry brushing and polishing. Not resistant to acids or alkalis. Heat tolerant to 370°F.

Ox Hair: The stiffest of soft animal hair, it is economical and often mixed with other fibers.

Pony Hair: A straight, soft hair without a fine point, it ranges in color from light to dark brown.

Red Sable: The most prized hair used in artist brushes has special qualities that include the ability to come to a needle-fine point and retain full elasticity. Pure red sable is even finer, and Kolinsky sable is the finest.

Synthetic Filament

Nylon: Extremely resilient, durable, and resistant to high heat and abrasion. Impervious to solvents, alkalis, most acids and common chemicals. Resistant to bacteria and mold, and heat tolerant to 250°F. 6.12 nylon is FDA approved.

Abrasive Nylon: Nylon bristles uniformly impregnated with an abrasive, such as aluminum oxide or silicon carbide. Sides of filament act as flexible files to reach surfaces where wire bristles might not be effective. Suitable for wet or dry deburring and finishing.

Static Dissipative Nylon aka Anti Static Nylon: A type 6.12 Nylon with a surface resistivity of $1 \times 10^9 \Omega/\text{cm}$ that does not shed or slough and is cleanroom compatible.

PEEK: Polyetheretherketone, a polymer, is extremely resistant to chemicals and can withstand heat up to 480°F.

Polyester: Has many of the properties of nylon, but will not mat or lose its stiffness when wet. In smaller diameters it has the appearance and feel of horse hair.

Polyethylene: A very flexible plastic that is ideal for applications that need soft wiping instead of brushing.

Polypropylene: A versatile plastic that stays stiff when wet. Inert to most solvents, oils, acids and chemicals. Heat tolerant to 225°F.

Taklon: A very fine nylon filament that is shaped like a natural hair. Very versatile and durable, it is most commonly used for artist and cosmetic brushes.

Thunderon®: A fine (.0015" diameter) acrylic fiber that has been chemically bonded with a layer of copper sulfide. It is conductive and can also be mixed with other fibers to add stiffness without diminishing its effectiveness.

Conductive Nylon: A type 6.6 or type 6 nylon with an electrically conductive coating suffused onto the surface. Available in .010 standard diameter, other sizes available by special order. Range of electrical resistance: $10^2 - 10^5 \Omega/\text{m}$.

Metal Wire

Aluminum: Soft and non-corrosive. Bends easily and takes a set. Recommended for special applications only.

Brass: Soft, flexible metal that is recommended for applications on soft metal surfaces.

Carbon Steel: Widely used fill material that has excellent cutting ability and fatigue resistance at a low cost.

Phosphor Bronze: Non-sparking, stronger and longer lasting than brass. Resists corrosion and fatigue.

Stainless Steel: Resistant to heat, rust and corrosion. Excellent for wet or dry applications. Stainless steel brush wire is also magnetic.

Titanium: Very strong and about half the weight of steel. Excellent resistance to corrosion, chlorides, saltwater and acids, and is essentially non-magnetic. It is ideal for use on titanium parts where galvanic corrosion is unacceptable.

Vegetable Fiber

Tampico: A durable, porous fiber from the Mexican agave plant that is heat, alkali and acid resistant. Works well for wet or dry applications. Tampico is anti-static and heat tolerant up to 280°F.

HOW BRUSHES ARE MEASURED

Handheld Brushes

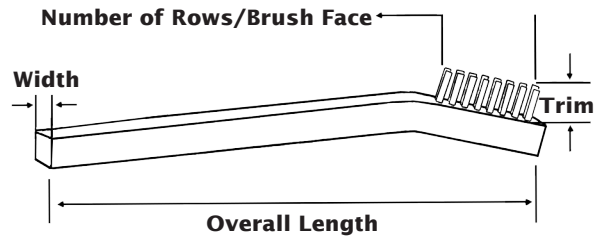

Block Brushes

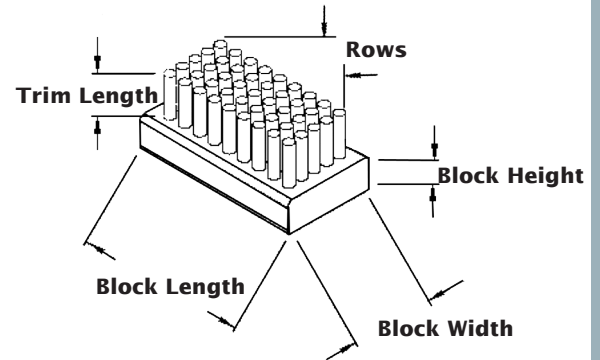

Applicator Brushes

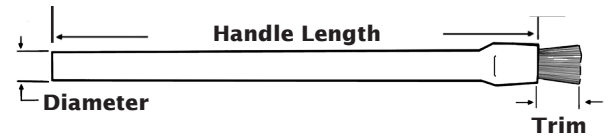

Artist Brushes

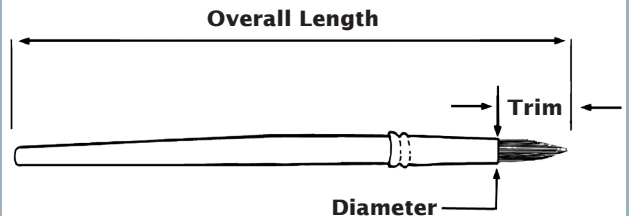

Spiral Brushes

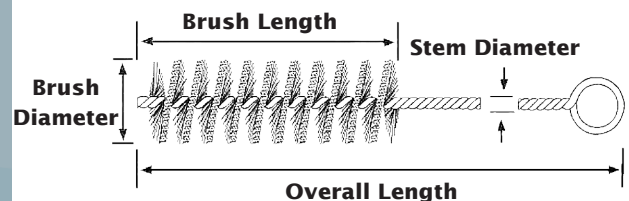

2 Row Wood Handle Brushes

Wood handle, bent for knuckle protection, and filled with thick tufts in a 2 x 9 row configuration. Slightly larger and heavier duty than our basic "toothbrush-style" 30 series below.



Part #	Fill Material	Trim	Rows	Handle (L x W)	Brush Face (L x W)
18A	.008 Aluminum	5/8"	2 x 9	8-1/4" x 1/2"	2-1/4" x 3/8"
18B	.006 Brass	5/8"	2 x 9	8-1/4" x 1/2"	2-1/4" x 3/8"
18B-012	.012 Brass	5/8"	2 x 9	8-1/4" x 1/2"	2-1/4" x 3/8"
18N	.018 Nylon	5/8"	2 x 9	8-1/4" x 1/2"	2-1/4" x 3/8"
18SS	.006 Stainless Steel	5/8"	2 x 9	8-1/4" x 1/2"	2-1/4" x 3/8"

3 Row Plywood Handle Brushes

Our 30 series is our most popular all-purpose "toothbrush-style," bent for knuckle protection. This standard tool is the basic brush for every tool kit.

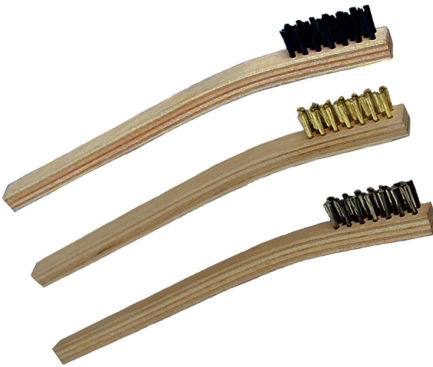

Part #	Fill Material	Trim	Rows	Handle (L x W)	Brush Face (L x W)
30B	.006 Brass	7/16"	3 x 7	7-3/4" x 7/16"	1-3/8" x 1/4"
◆ 30CK	Hog bristle	7/16"	3 x 7	7-3/4" x 7/16"	1-3/8" x 1/4"
◆ 30HH	Horse hair	7/16"	3 x 7	7-3/4" x 7/16"	1-3/8" x 1/4"
30N	.018 Nylon	7/16"	3 x 7	7-3/4" x 7/16"	1-3/8" x 1/4"
30N-012	.012 Nylon	7/16"	3 x 7	7-3/4" x 7/16"	1-3/8" x 1/4"
30PB	.006 Phosphor bronze	7/16"	3 x 7	7-3/4" x 7/16"	1-3/8" x 1/4"
30SS	.006 Stainless steel	7/16"	3 x 7	7-3/4" x 7/16"	1-3/8" x 1/4"
30T	Tampico	7/16"	3 x 7	7-3/4" x 7/16"	1-3/8" x 1/4"
30KIT	3 Brush Set: (1) 30B, (1) 30N, (1) 30SS				

4 Row Plywood Handle Brushes

A popular larger brush with a strong plywood handle and a fill material for any surface. Works well for cleaning or roughing.



Part #	Fill Material	Trim	Rows	Handle (L x W)	Brush Face (L x W)
36B	.008 Brass	3/4"	4 x 9	8-1/4" x 1-1/16"	2-1/8" x 7/8"
◆ 36CK	Hog bristle	3/4"	4 x 9	8-1/4" x 1-1/16"	2-1/8" x 7/8"
◆ 36HH	Horse hair	3/4"	4 x 9	8-1/4" x 1-1/16"	2-1/8" x 7/8"
36N	.018 Nylon	3/4"	4 x 9	8-1/4" x 1-1/16"	2-1/8" x 7/8"
36SS	.008 Stainless steel	3/4"	4 x 9	8-1/4" x 1-1/16"	2-1/8" x 7/8"

5 Row Wood Handle Brushes

Large hand-held brush with a wood handle that is shaped for an easier grip. Wider brush face is great for roughing and/or washing large surfaces.



Part #	Fill Material	Trim	Rows	Handle (L x W)	Brush Face (L x W)
28AL	.008 Crimped Aluminum	5/8"	5 x 9	8" x 1-1/2"	2-1/8" x 1-1/4"
28B	.006 Brass	5/8"	5 x 9	8" x 1-1/2"	2-1/8" x 1-1/4"
28B008	.008 Brass	5/8"	5 x 9	8" x 1-1/2"	2-1/8" x 1-1/4"
◆ 28CK	Hog bristle	5/8"	5 x 9	8" x 1-1/2"	2-1/8" x 1-1/4"
28CS	.006 Carbon steel	5/8"	5 x 9	8" x 1-1/2"	2-1/8" x 1-1/4"
28CS008	.008 Carbon steel	5/8"	5 x 9	8" x 1-1/2"	2-1/8" x 1-1/4"
◆ 28HH	Horse hair	5/8"	5 x 9	8" x 1-1/2"	2-1/8" x 1-1/4"
28N	.018 Nylon	5/8"	5 x 9	8" x 1-1/2"	2-1/8" x 1-1/4"
28SS	.006 Stainless steel	5/8"	5 x 9	8" x 1-1/2"	2-1/8" x 1-1/4"
28SS008	.008 Stainless steel	5/8"	5 x 9	8" x 1-1/2"	2-1/8" x 1-1/4"

Plastic Handle Brushes

Plastic “toothbrush-style” handle, designed with hand grips, and bent to allow knuckle room and prevent hand scraping. Standard handle color is black. Also available with a red, white or blue handle with nylon fill.

Part #	Fill Material	Trim	Rows	Handle (L x W)	Brush Face (L x W)
21B	.006 Brass	7/16"	3 x 7	7-3/16" x 7/16"	1-3/8" x 1/4"
21CS	.006 Carbon steel	7/16"	3 x 7	7-3/16" x 7/16"	1-3/8" x 1/4"
◆ 21HH	Horse hair	7/16"	3 x 7	7-3/16" x 7/16"	1-3/8" x 1/4"
21N	.012 Nylon	7/16"	3 x 7	7-3/16" x 7/16"	1-3/8" x 1/4"
21N-016	.016 Nylon	7/16"	3 x 7	7-3/16" x 7/16"	1-3/8" x 1/4"
21N-020	.020 Nylon	7/16"	3 x 7	7-3/16" x 7/16"	1-3/8" x 1/4"
▲ 21N-ESD	.010 S.D. Nylon* (medium)	7/16"	3 x 7	7-3/16" x 7/16"	1-3/8" x 1/4"
▲ 21N-ESD-016	.016 S.D. Nylon* (stiff)	7/16"	3 x 7	7-3/16" x 7/16"	1-3/8" x 1/4"
▲ 21N-ESD-LT	.010 S.D. Nylon* (soft)	3/4"	3 x 7	7-3/16" x 7/16"	1-3/8" x 1/4"
21PB	.006 Phosphor bronze	7/16"	3 x 7	7-3/16" x 7/16"	1-3/8" x 1/4"
21SS	.006 Stainless Steel	7/16"	3 x 7	7-3/16" x 7/16"	1-3/8" x 1/4"
21N-020W-BLU	.020 Nylon/blue handle	7/16"	3 x 7	7-3/16" x 7/16"	1-3/8" x 1/4"
21N-020W-RED	.020 Nylon/red handle	7/16"	3 x 7	7-3/16" x 7/16"	1-3/8" x 1/4"
21N-020W-WHT	.020 Nylon/white handle	7/16"	3 x 7	7-3/16" x 7/16"	1-3/8" x 1/4"
21KIT	3 Brush Set: (1) 21B, (1) 21N-016, (1) 21SS				

* Static Dissipative Nylon (see page 2 for description)



Plastic Handle Long Trim Brushes

Same “toothbrush-style” as above, but with a longer 1” trim for softer brushing action. Recommended for gentle dusting and cleaning.

Part #	Fill Material	Trim	Rows	Handle (L x W)	Brush Face (L x W)
◆ 21HHLT	Horse hair	1"	3 x 7	7-3/16" x 7/16"	1-3/8" x 1/4"
21NLT	.008 Nylon	1"	3 x 7	7-3/16" x 7/16"	1-3/8" x 1/4"



Plastic Handle Double-Headed Brushes

Double-headed “toothbrush-style” brush has a black plastic handle with hand grips and a different fill material on each side.

Part #	Fill Material	Trim	Rows	Handle (L x W)	Brush Face (L x W)
321BN	.008 Brass/.018 Nylon	1/2"	3 x 7	7-1/16" x 1/2"	1-3/8" x 1/4"
321PBN	.008 Phosphor bronze/ .018 Nylon	1/2"	3 x 7	7-1/16" x 1/2"	1-3/8" x 1/4"
321SSN	.006 Stainless steel/ .018 Nylon	1/2"	3 x 7	7-1/16" x 1/2"	1-3/8" x 1/4"



Plastic Handle Double-Headed Brushes

Black plastic handle with two brush faces on a triangular head, specifically designed for ample knuckle clearance. Overall brush is 7-1/4” long and 2-1/8” wide at the head.

Part #	Fill Material	Trim	Rows	Brush Face (L x W)
221BN	.006 Brass/.016 Nylon	7/16"	3 x 7	1-3/8" x 5/16"
221BPB	.006 Brass/.006 Phosphor bronze	7/16"	3 x 7	1-3/8" x 5/16"
◆ 221CKHH	Hog bristle/Horse hair	7/16"	3 x 7	1-3/8" x 5/16"
221NN	.012 Nylon/.016 Nylon	7/16"	3 x 7	1-3/8" x 5/16"
221PBN	.006 Phosphor bronze/.016 Nylon	7/16"	3 x 7	1-3/8" x 5/16"
221SSB	.006 Stainless steel/.006 Brass	7/16"	3 x 7	1-3/8" x 5/16"
221SSN	.006 Stainless steel/.016 Nylon	7/16"	3 x 7	1-3/8" x 5/16"
221SSSS	.006 Stainless steel/.006 Stainless steel	7/16"	3 x 7	1-3/8" x 5/16"



Plastic Handle All-Purpose Brush

“Toothbrush-style” used for cleaning small parts.

Part #	Fill Material	Handle Length	Brush Face (L x W)	Trim	Rows
200399	End A: .014 Nylon	7"	1-3/8" x 1/4"	7/16" (With notch)	3 x 12
	End B: .010 Nylon		7/8" x 1/8"	3/16" (Narrow end)	1 x 7
251993	.010 Black nylon	6-5/8"	1.8" x .4"	1/2"	4 x 14



◆ Anti-Static ▲ Static Dissipative ● Conductive

Aluminum Handle Hand-Laced Brushes

Aluminum handle “toothbrush-style” scratch brush with 1, 2, or 3 rows of bristles, hand-tied into the handle for maximum bristle retention.



Hand-Laced Brushes

Hand-laced brushes are the premium brushes of the industry. Each fiber tuft is tied into position by hand, resulting in a superior quality brush with heavy density and maximum fiber retention.

Part #	Fill Material	Trim	Rows	Handle (L x W)	Brush Face (L x W)
● 11BA	.003 Brass	7/16"	1 x 11	6-7/16" x 1/8"	1-1/8" x 1/8"
● 22BA	.003 Brass	7/16"	2 x 11	6-7/16" x 1/4"	1-1/4" x 1/4"
● 33BA	.003 Brass	7/16"	3 x 11	6-7/16" x 3/8"	1-1/4" x 5/16"
◆ 22GA	.006 Goat hair	7/16"	2 x 11	6-7/16" x 1/4"	1-1/4" x 1/4"
◆ 11CKA	Hog bristle	7/16"	1 x 11	6-7/16" x 1/8"	1-1/8" x 1/8"
◆ 22CKA	Hog bristle	7/16"	2 x 11	6-7/16" x 1/4"	1-1/4" x 1/4"
◆ 33CKA	Hog bristle	7/16"	3 x 11	6-7/16" x 3/8"	1-1/4" x 5/16"
◆ 11HHA	Horse hair	7/16"	1 x 11	6-7/16" x 1/8"	1-1/8" x 1/8"
◆ 22HHA	Horse hair	7/16"	2 x 11	6-7/16" x 1/4"	1-1/4" x 1/4"
◆ 33HHA	Horse hair	7/16"	3 x 11	6-7/16" x 3/8"	1-1/4" x 5/16"
11NA	.012 Nylon	7/16"	1 x 11	6-7/16" x 1/8"	1-1/8" x 1/8"
22NA	.012 Nylon	7/16"	2 x 11	6-7/16" x 1/4"	1-1/4" x 1/4"
33NA	.012 Nylon	7/16"	3 x 11	6-7/16" x 3/8"	1-1/4" x 5/16"
11PA	.006 PEEK	7/16"	1 x 11	6-7/16" x 1/8"	1-1/8" x 1/8"
22PA	.006 PEEK	7/16"	2 x 11	6-7/16" x 1/4"	1-1/4" x 1/4"
33PA	.006 PEEK	7/16"	3 x 11	6-7/16" x 3/8"	1-1/4" x 5/16"
▲ 11SDA	.016 S.D. Nylon*	7/16"	1 x 11	6-7/16" x 1/8"	1-1/8" x 1/8"
▲ 22SDA	.016 S.D. Nylon*	7/16"	2 x 11	6-7/16" x 1/4"	1-1/4" x 1/4"
▲ 33SDA	.016 S.D. Nylon*	7/16"	3 x 11	6-7/16" x 3/8"	1-1/4" x 5/16"
● 11SSA	.003 Stainless steel	7/16"	1 x 11	6-7/16" x 1/8"	1-1/8" x 1/8"
● 22SSA	.003 Stainless steel	7/16"	2 x 11	6-7/16" x 1/4"	1-1/4" x 1/4"
● 33SSA	.003 Stainless steel	7/16"	3 x 11	6-7/16" x 3/8"	1-1/4" x 5/16"
▲ 11S9A	.010 S.D. Nylon*	7/16"	1 x 11	6-7/16" x 1/8"	1-1/8" x 1/8"
▲ 22S9A	.010 S.D. Nylon*	7/16"	2 x 11	6-7/16" x 1/4"	1-1/4" x 1/4"
▲ 33S9A	.010 S.D. Nylon*	7/16"	3 x 11	6-7/16" x 3/8"	1-1/4" x 5/16"
● 11TA	Thunderon®	7/16"	1 x 11	6-7/16" x 1/8"	1-1/8" x 3/16"
● 33TA	Thunderon®	7/16"	2 x 11	6-7/16" x 3/8"	1-1/4" x 5/16"
● 11TIA	.008 Titanium	7/16"	1 x 11	6-7/16" x 1/8"	1-1/8" x 1/8"
● 22TIA	.008 Titanium	7/16"	2 x 11	6-7/16" x 1/4"	1-1/4" x 1/4"
● 33TIA	.008 Titanium	7/16"	3 x 11	6-7/16" x 3/8"	1-1/4" x 5/16"

Dense stiff tufts for applications requiring firm action:

● 11AL316SS	.006 Stainless steel	7/16"	1 x 11	6-7/16" x 1/8"	1-1/2" x 3/16"
-------------	----------------------	-------	--------	----------------	----------------

*Static Dissipative Nylon

Acetal Handle Hand-Laced Brushes

1, 2, or 3 rows hand-tied into an acetal or static dissipative acetal handle. Autoclavable for cleanroom or sterile applications. Meets FDA 21 CFR-177, 2480 and ASTM D-6100 standards.



Part #	Fill Material	Trim	Rows	Handle (L x W)	Brush Face (L x W)
11ND	.012 Nylon	7/16"	1 x 11	6-1/4" x 3/16"	1-1/8" x 1/8"
22ND	.012 Nylon	7/16"	2 x 11	6-1/4" x 5/16"	1-1/4" x 1/4"
33ND	.012 Nylon	7/16"	3 x 11	6-1/4" x 3/8"	1-1/4" x 5/16"
11ND-003	.003 Nylon	7/16"	1 x 11	6-1/4" x 3/16"	1-1/8" x 1/8"
22ND-003	.003 Nylon	7/16"	2 x 11	6-1/4" x 5/16"	1-1/4" x 1/4"
33ND-003	.003 Nylon	7/16"	3 x 11	6-1/4" x 3/8"	1-1/4" x 5/16"
11SSD	.003 Stainless steel	7/16"	1 x 11	6-1/4" x 3/16"	1-1/8" x 1/8"
22SSD	.003 Stainless steel	7/16"	2 x 11	6-1/4" x 5/16"	1-1/4" x 1/4"
33SSD	.003 Stainless steel	7/16"	3 x 11	6-1/4" x 3/8"	1-1/4" x 5/16"
▲ 11S9X*	.010 S. D. Nylon*	7/16"	1 x 11	6-1/4" x 3/16"	1-1/8" x 1/8"
▲ 22S9X*	.010 S. D. Nylon*	7/16"	2 x 11	6-1/4" x 5/16"	1-1/4" x 1/4"
▲ 33S9X*	.010 S. D. Nylon*	7/16"	3 x 11	6-1/4" x 3/8"	1-1/4" x 5/16"
▲ 11SDX*	.016 S. D. Nylon*	7/16"	1 x 11	6-1/4" x 3/16"	1-1/8" x 1/8"
▲ 22SDX*	.016 S. D. Nylon*	7/16"	2 x 11	6-1/4" x 5/16"	1-1/4" x 1/4"
▲ 33SDX*	.016 S. D. Nylon*	7/16"	3 x 11	6-1/4" x 3/8"	1-1/4" x 5/16"
11TID	.008 Titanium	7/16"	1 x 11	6-1/4" x 3/16"	1-1/8" x 1/8"
22TID	.008 Titanium	7/16"	2 x 11	6-1/4" x 5/16"	1-1/4" x 1/4"
33TID	.008 Titanium	7/16"	3 x 11	6-1/4" x 3/8"	1-1/4" x 5/16"

* Static Dissipative Acetal Handle and Static Dissipative Nylon

Plywood Handle Hand-Laced Brushes

“Toothbrush-style” plywood handle. Fill material hand-tied with stainless steel wire, remains secure even in wet environments when wood handle expands and contracts. Greater density than staple set brushes.

Part #	Fill Material	Trim	Rows	Handle (L x W)	Brush Face (L x W)
15A	.008 Aluminum	7/16"	3 x 7	7-3/4" x 7/16"	1-1/2" x 1/4"
11BP	.006 Brass	7/16"	1 x 10	7-3/4" x 1/4"	1-3/8" x 1/8"
14B	.006 Brass	7/16"	2 x 8	7-3/4" x 3/8"	1-3/8" x 1/4"
15B	.006 Brass	7/16"	3 x 7	7-3/4" x 7/16"	1-1/2" x 1/4"
11BP-003	.003 Brass	7/16"	1 x 10	7-3/4" x 1/4"	1-3/8" x 1/8"
14B-003	.003 Brass	7/16"	2 x 8	7-3/4" x 3/8"	1-3/8" x 1/4"
15B-003	.003 Brass	7/16"	3 x 7	7-3/4" x 7/16"	1-1/2" x 1/4"
◆ 11CKP	Hog bristle	7/16"	1 x 10	7-3/4" x 1/4"	1-3/8" x 1/8"
◆ 14CK	Hog bristle	7/16"	2 x 8	7-3/4" x 3/8"	1-3/8" x 1/4"
◆ 15CK	Hog bristle	7/16"	3 x 7	7-3/4" x 7/16"	1-1/2" x 1/4"
◆ 11HHP	Horse hair	7/16"	1 x 10	7-3/4" x 1/4"	1-3/8" x 1/8"
◆ 14HH	Horse hair	7/16"	2 x 8	7-3/4" x 3/8"	1-3/8" x 1/4"
◆ 15HH	Horse hair	7/16"	3 x 7	7-3/4" x 7/16"	1-1/2" x 1/4"
11NP	.012 Nylon	7/16"	1 x 10	7-3/4" x 1/4"	1-3/8" x 1/8"
14N	.012 Nylon	7/16"	2 x 8	7-3/4" x 3/8"	1-3/8" x 1/4"
15N	.018 Nylon	7/16"	3 x 7	7-3/4" x 7/16"	1-1/2" x 1/4"
15P	.006 PEEK	7/16"	3 x 7	7-3/4" x 7/16"	1-1/2" x 1/4"
11PBP	.006 Phosphor bronze	7/16"	1 x 10	7-3/4" x 1/4"	1-3/8" x 1/8"
14PB	.006 Phosphor bronze	7/16"	2 x 8	7-3/4" x 3/8"	1-3/8" x 1/4"
15PB	.006 Phosphor bronze	7/16"	3 x 7	7-3/4" x 7/16"	1-1/2" x 1/4"
11SSP	.006 Stainless steel	7/16"	1 x 10	7-3/4" x 1/4"	1-3/8" x 1/8"
14SS	.006 Stainless steel	7/16"	2 x 8	7-3/4" x 3/8"	1-3/8" x 1/4"
15SS	.006 Stainless steel	7/16"	3 x 7	7-3/4" x 7/16"	1-1/2" x 1/4"
11SSP-003	.003 Stainless steel	7/16"	1 x 10	7-3/4" x 1/4"	1-3/8" x 1/8"
14SS-003	.003 Stainless steel	7/16"	2 x 8	7-3/4" x 3/8"	1-3/8" x 1/4"
15SS-003	.003 Stainless steel	7/16"	3 x 7	7-3/4" x 7/16"	1-1/2" x 1/4"



Long Handle Hand-Laced Brushes

Same width and trim length as the 15 series (above), but with an extra long 14" handle for a longer reach.

Part #	Fill Material	Trim	Rows	Handle (L x W)	Brush Face (L x W)
15BL	.006 Brass	7/16"	3 x 7	14" x 7/16"	1-1/2" x 1/4"
15BL-003	.003 Brass	7/16"	3 x 7	14" x 7/16"	1-1/2" x 1/4"
◆ 15CKL	Hog bristle	7/16"	3 x 7	14" x 7/16"	1-1/2" x 1/4"
◆ 15HHL	Horse hair	7/16"	3 x 7	14" x 7/16"	1-1/2" x 1/4"
15NL	.018 Nylon	7/16"	3 x 7	14" x 7/16"	1-1/2" x 1/4"
15PBL	.006 Phosphor bronze	7/16"	3 x 7	14" x 7/16"	1-1/2" x 1/4"
15SSL	.006 Stainless steel	7/16"	3 x 7	14" x 7/16"	1-1/2" x 1/4"
15SSL-003	.003 Stainless steel	7/16"	3 x 7	14" x 7/16"	1-1/2" x 1/4"



60° Angle Hand-Laced Brushes

Laminated plywood handle bent at a 60° angle, designed to facilitate cleaning at unusual angles and hard to reach places.

Part #	Fill Material	Trim	Rows	Handle (L x W)	Brush Face (L x W)
60B	.006 Brass	7/16"	3 x 7	7-3/4" x 7/16"	1-1/4" x 1/4"
◆ 60CK	Hog bristle	7/16"	3 x 7	7-3/4" x 7/16"	1-1/4" x 1/4"
◆ 60HH	Horse hair	7/16"	3 x 7	7-3/4" x 7/16"	1-1/4" x 1/4"
60N	.018 Nylon	7/16"	3 x 7	7-3/4" x 7/16"	1-1/4" x 1/4"
60PB	.006 Phosphor bronze	7/16"	3 x 7	7-3/4" x 7/16"	1-1/4" x 1/4"
60SS	.006 Stainless steel	7/16"	3 x 7	7-3/4" x 7/16"	1-1/4" x 1/4"

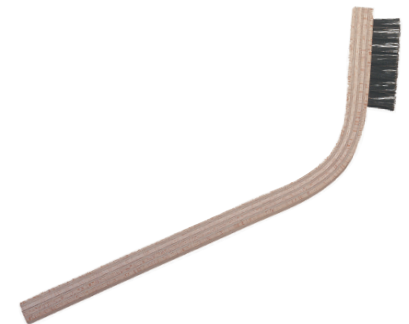

Heavy Duty Hand-Laced Brushes

Filament is hand-tied with stainless wire into a heavy-duty plywood handle for maximum fiber retention.

Part #	Fill Material	Trim	Rows	Handle (L x W)	Brush Face (L x W)
46B	.006 Brass	3/4"	7 x 7	8-1/2" x 1"	1-5/8" x 7/8"
◆ 46CK	Hog bristle	3/4"	7 x 7	8-1/2" x 1"	1-5/8" x 7/8"
◆ 46HH	Horse hair	3/4"	7 x 7	8-1/2" x 1"	1-5/8" x 7/8"
46SS	.006 Stainless steel	3/4"	7 x 7	8-1/2" x 1"	1-5/8" x 7/8"
81SS	.006 Stainless steel	3/4"	7 x 11	8-1/2" x 1"	2-5/8" x 7/8"



◆ Anti-Static ▲ Static Dissipative ● Conductive



Heavy Duty Scratch Brush with Scraper

Heavy duty brush has a scraper attached to a flat wood handle for cleaning paint, rust and dirt off welds and castings.

Part #	Fill Material	Trim	Rows	Handle (L x W)	Brush Face (L x W)
484CSC	.014 Carbon steel	1-1/2"	4 x 11	11" x 1-1/2"	4-1/2" x 1-3/16"

Shoe Handle Scratch Brushes

Solid hardwood shoe handle, contoured for a comfortable grip, filled with durable metal for cleaning abrasion-resistant materials.

Part #	Fill Material	Trim	Rows	Handle (L x W)	Brush Face (L x W)
444B	.012 Brass	1-1/8"	4 x 16	10" x 1-1/8"	4-3/4" x 3/4"
441CS	.013 Carbon steel	1-1/8"	1 x 17	10-3/16" x 3/8"	4-7/8" x 1/8"
442CS	.013 Carbon steel	1-3/16"	2 x 17	10-1/4" x 3/4"	5" x 3/8"
443CS	.013 Carbon steel	1-1/8"	3 x 16	10" x 1"	4-3/4" x 5/8"
444CS	.013 Carbon steel	1-1/8"	4 x 16	10" x 1-1/8"	4-3/4" x 3/4"
444PB	.012 Phosphor bronze	1-1/8"	4 x 16	10" x 1-1/8"	4-3/4" x 3/4"
441SS	.012 Stainless steel	1-1/8"	1 x 17	10-3/16" x 3/8"	4-7/8" x 1/8"
441SS-3/4	.012 Stainless steel	3/4"	1 x 17	10-3/16" x 3/8"	4-7/8" x 1/8"
442SS	.012 Stainless steel	1-3/16"	2 x 17	10-1/4" x 3/4"	5" x 3/8"
443SS	.012 Stainless steel	1-1/8"	3 x 16	10" x 1"	4-3/4" x 5/8"
444SS	.012 Stainless steel	1-1/8"	4 x 16	10" x 1-1/8"	4-3/4" x 3/4"

Economy Brushes: Less wire fill for a more economical price:

444CSE	.013 Carbon steel	1-1/8"	4 x 16	10" x 1-1/8"	4-3/4" x 3/4"
444SSE	.012 Stainless steel	1-1/8"	4 x 16	10" x 1-1/8"	4-3/4" x 3/4"

Shoe Handle with Scraper:

444CSC	.013 Carbon steel	1-1/8"	4 x 16	10" x 1-1/8"	4-3/4" x 3/4"
444SSC	.012 Stainless steel	1-1/8"	4 x 16	10" x 1-1/8"	4-3/4" x 3/4"

Contoured Plastic Shoe Handle:

444CSP	.013 Carbon steel	1-1/8"	4 x 16	10" x 1-1/8"	4-3/4" x 3/4"
444SSP	.012 Stainless steel	1-1/8"	4 x 16	10" x 1-1/8"	4-3/4" x 3/4"

Long Handle Scratch Brushes

Long, slightly curved hardwood or plastic handle with 2, 3, or 4 rows, densely filled with even trim for uniform cleaning.

Part #	Fill Material	Trim	Rows	Handle (L x W)	Brush Face (L x W)
403B	.012 Brass	1-1/8"	3 x 19	13-3/4" x 15/16"	5-3/4" x 1/2"
414B	.012 Brass	1-1/8"	4 x 19	13-3/4" x 1-1/8"	5-3/8" x 3/4"
402CS	.013 Carbon steel	1-1/8"	2 x 18	13-3/4" x 11/16"	5-3/8" x 3/8"
900146	.013 Carbon steel	1-1/8"	3 x 11	13-3/4" x 15/16"	4" x 1/2"
403CS	.013 Carbon steel	1-1/8"	3 x 19	13-3/4" x 15/16"	5-3/4" x 1/2"
414CS	.013 Carbon steel	1-1/8"	4 x 19	13-3/4" x 1-1/8"	5-3/8" x 3/4"
403PB	.012 Phosphor bronze	1-1/8"	3 x 19	13-3/4" x 15/16"	5-3/4" x 1/2"
414PB	.012 Phosphor bronze	1-1/8"	4 x 19	13-3/4" x 1-1/8"	5-3/8" x 3/4"
403SS	.012 Stainless steel	1-1/8"	3 x 19	13-3/4" x 15/16"	5-3/4" x 1/2"
414SS	.012 Stainless steel	1-1/8"	4 x 19	13-3/4" x 1-1/8"	5-3/8" x 3/4"

Economy Brushes: Less wire fill for a more economical price:

403CSE	.013 Carbon steel	1-1/8"	3 x 19	13-3/4" x 15/16"	5-3/4" x 1/2"
414CSE	.013 Carbon steel	1-1/8"	4 x 19	13-3/4" x 1-1/8"	5-3/8" x 3/4"
403SSE	.012 Stainless steel	1-1/8"	3 x 19	13-3/4" x 15/16"	5-3/4" x 1/2"
414SSE	.012 Stainless steel	1-1/8"	4 x 19	13-3/4" x 1-1/8"	5-3/8" x 3/4"

Long Handle Brushes with Scrapers:

403CSC	.013 Carbon steel	1-1/8"	3 x 19	13-3/4" x 15/16"	5-3/4" x 1/2"
414CSC	.013 Carbon steel	1-1/8"	4 x 19	13-3/4" x 1-1/8"	5-3/8" x 3/4"
403SSC	.012 Stainless steel	1-1/8"	3 x 19	13-3/4" x 15/16"	5-3/4" x 1/2"
414SSC	.012 Stainless steel	1-1/8"	4 x 19	13-3/4" x 1-1/8"	5-3/8" x 3/4"

Curved Plastic Handle Brushes:

403CSP	.013 Carbon steel	1-1/8"	3 x 19	13-3/4" x 7/8"	5-3/4" x 1/2"
414SSP	.012 Stainless steel	1-1/8"	4 x 19	13-3/4" x 1-1/8"	5-3/8" x 3/4"

Long Handle Brushes with V-shaped trim:

902984	.012 Stainless steel	1-1/4"	3 x 13	13-3/4" x 1-1/8"	5-1/4" x 5/16"
902984CS	.012 Carbon steel	1-1/4"	3 x 13	13-3/4" x 1-1/8"	5-1/4" x 5/16"



Shoe Handle Platers' Brushes

Platers' brushes made with fine fill material are recommended for use on plated parts and for fine metal finishing. Hardwood shoe handle is contoured for a comfortable grip.

Part #	Fill Material	Trim	Rows	Handle (L x W)	Brush Face (L x W)
443B006	.006 Brass	1-1/8"	3 x 16	10" x 1"	4-3/4" x 5/8"
444B006	.006 Brass	1-1/8"	4 x 16	10" x 1-1/8"	4-3/4" x 3/4"
443CS006	.006 Carbon steel	1-1/8"	3 x 16	10" x 1"	4-3/4" x 5/8"
444CS006	.006 Carbon steel	1-1/8"	4 x 16	10" x 1-1/8"	4-3/4" x 3/4"
444N	.018 Nylon	1"	4 x 16	10" x 1-1/8"	4-3/4" x 3/4"
444SS-006	.006 Stainless steel	1-1/8"	4 x 16	10" x 1-1/8"	4-3/4" x 3/4"
444T	Tampico	1"	4 x 16	10" x 1-1/8"	4-3/4" x 3/4"

Long Handle Platers' Brushes

Long, slightly curved hardwood handle with 2, 3, or 4 rows, densely filled, for uniform cleaning and polishing.

Part #	Fill Material	Trim	Rows	Handle (L x W)	Brush Face (L x W)
403B-006	.006 Brass	1-1/8"	3 x 19	13-3/4" x 15/16"	5-3/4" x 1/2"
414B006	.006 Brass	1-1/8"	4 x 19	13-3/4" x 1-1/8"	5-3/8" x 3/4"
◆ 403CK	Hog bristle	1"	3 x 19	13-3/4" x 15/16"	5-3/4" x 1/2"
◆ 403CK-LT	Hog bristle	1-7/8"	3 x 19	13-3/4" x 15/16"	5-3/4" x 1/2"
◆ 414CK	Hog bristle	1-1/8"	4 x 19	13-3/4" x 1-1/8"	5-3/8" x 3/4"
403CS006	.006 Carbon steel	1-1/8"	3 x 19	13-3/4" x 15/16"	5-3/4" x 1/2"
414CS006	.006 Carbon steel	1-1/8"	4 x 19	13-3/4" x 1-1/8"	5-3/8" x 3/4"
◆ 403HH	Horse hair	1"	3 x 19	13-3/4" x 15/16"	5-3/4" x 1/2"
◆ 414HH	Horse hair	1"	4 x 19	13-3/4" x 1-1/8"	5-3/8" x 3/4"
403N	.018 Nylon	1"	3 x 19	13-3/4" x 15/16"	5-3/4" x 1/2"
414N	.018 Nylon	1"	4 x 19	13-3/4" x 1-1/8"	5-3/8" x 3/4"
414N-014	.014 Nylon	1"	4 x 19	13-3/4" x 1-1/8"	5-3/8" x 3/4"
403SS-006	.006 Stainless steel	1-1/8"	3 x 19	13-3/4" x 15/16"	5-3/4" x 1/2"
414SS-006	.006 Stainless steel	1-1/8"	4 x 19	13-3/4" x 1-1/8"	5-3/8" x 3/4"
414T	Tampico	1"	4 x 19	12-7/8" x 1-3/16"	5-3/8" x 3/4"

Curved Plastic Handle:

414PN	.018 Nylon	1-1/8"	4 x 19	13-3/4" x 1-1/8"	5-3/8" x 3/4"
-------	------------	--------	--------	------------------	---------------

Narrow Long Handle Platers' Brushes

Part #299991 has a slightly curved plywood handle. Part #359994 has a straight hardwood handle. Both brushes work well for cleaning long, narrow areas.

Part #	Fill Material	Trim	Rows	Handle (L x W)	Brush Face (L x W)
◆ 299991CK	Hog bristle	7/16"	3 x 20	7-3/4" x 7/16"	4" x 1/4"
◆ 299991HH	Horse hair	7/16"	3 x 20	7-3/4" x 7/16"	4" x 1/4"
◆ 299991-5/16	Horse hair	5/16"	3 x 20	7-3/4" x 7/16"	4" x 1/4"
◆ 359994	Horse hair	3/4"	4 x 29	10-3/16" x 13/16"	5" x 1/2"

Potash Hand-Tied Cotton Brush

Extra soft swab brush made with heavy cotton yarn, hand-sewn with nylon thread into a wood handle. Great for polishing aluminum.

Part #	Fill Material	Handle (L x W)	Brush Face (L x W)
900504	100% Cotton	12-7/8" x 1-1/4"	8" x 4-1/2"

Platers' Brushes

Platers' brushes are designed for hand brushing, plating and fine metal finishing. The fill materials are softer than those used in scratch brushes. Refer to the Material Guide on page 2 for information and characteristics on each fill material.



Small Block Brushes

Small, handheld block brushes, often called mushroom or vegetable brushes, essential for cleaning small items. Available with either plastic (part #869903) or wood (part #869904) handles.

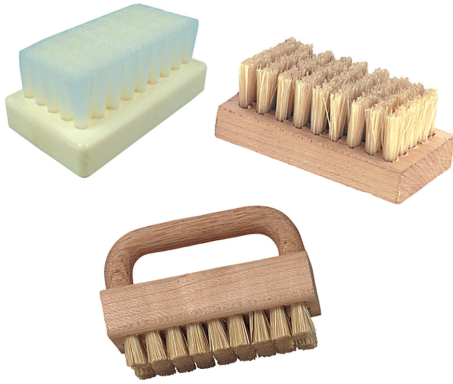

Part #	Fill Material	Trim	Rows	Block (L x W)	Brush Face (L x W)
869903	.006 Crimped polyester	5/8"	5 x 9	2-1/2" x 1-7/16"	2-1/4" x 1-1/4"
869903N	.006 Crimped nylon	5/8"	5 x 9	2-1/2" x 1-7/16"	2-1/4" x 1-1/4"
869904	.006 Crimped polyester	5/8"	5 x 9	2-1/2" x 1-3/8"	2-1/4" x 1-1/4"
◆ 869904CK	Hog bristle	5/8"	5 x 9	2-1/2" x 1-3/8"	2-1/4" x 1-1/4"
◆ 869904HH	Horse hair	5/8"	5 x 9	2-1/2" x 1-3/8"	2-1/4" x 1-1/4"
◆ 900492CK	Hog bristle*	1/2"	6 x 9	3-1/2" x 2-1/4"	3-1/4" x 2"
◆ 900492HH	Horse hair*	1/2"	6 x 9	3-1/2" x 2-1/4"	3-1/4" x 2"

* Wood handle

Fine—Filament Wood Block Brushes

Small, easy-to-grip hardwood block brushes, traditionally used by professional printers and graphic artists. It is also very effective for safely cleaning, polishing and deburring easily scratched surfaces.



Part #	Fill Material	Trim	Rows	Block (L x W)	Brush Face (L x W)
G1308	.005 Brass/Horse hair*	3/4"	10 x 16	4-1/4" x 2-1/2"	3-7/8" x 2-1/4"
G1308B	.005 Brass	3/4"	10 x 16	4-1/4" x 2-1/2"	3-7/8" x 2-1/4"
G1308B003	.003 Brass	3/4"	10 x 16	4-1/4" x 2-1/2"	3-7/8" x 2-1/4"
◆ G1308HH	Horse hair	3/4"	10 x 16	4-1/4" x 2-1/2"	3-7/8" x 2-1/4"
G1308N	.012 Nylon	3/4"	10 x 16	4-1/4" x 2-1/2"	3-7/8" x 2-1/4"
G1308SS	.005 Stainless steel	3/4"	10 x 16	4-1/4" x 2-1/2"	3-7/8" x 2-1/4"
G1308SSHH	.005 Stainless steel/ Horse hair*	3/4"	10 x 16	4-1/4" x 2-1/2"	3-7/8" x 2-1/4"
G1308SS003	.003 Stainless steel	3/4"	10 x 16	4-1/4" x 2-1/2"	3-7/8" x 2-1/4"

* Horse hair border helps contain liquid spray while brushing.

Fine—Filament Plastic Block Brushes

Small, easy-to-grip blue polypropylene block brushes, used to clean in wet application, where chemical cleaners and solvents are required. It is also very effective at safely cleaning, polishing and deburring easily scratched areas.



Part #	Fill Material	Trim	Rows	Block (L x W)	Brush Face (L x W)
G1308BP	.0045 Brass	3/4"	10 x 16	4-1/4" x 2-1/2"	3-7/8" x 2-1/4"
G1308B003P	.003 Brass	3/4"	10 x 16	4-1/4" x 2-1/2"	3-7/8" x 2-1/4"
G1308HHP	Horse hair	3/4"	10 x 16	4-1/4" x 2-1/2"	3-7/8" x 2-1/4"
G1308NP	.012 Black nylon	3/4"	10 x 16	4-1/4" x 2-1/2"	3-7/8" x 2-1/4"
G1308SS003P	.003 Stainless steel	3/4"	10 x 16	4-1/4" x 2-1/2"	3-7/8" x 2-1/4"
G1308SSP	.005 Stainless steel	3/4"	10 x 16	4-1/4" x 2-1/2"	3-7/8" x 2-1/4"

Hand Scrub Block Brushes

Medium sized rectangular hardwood block. Perfect size for scrubbing carpet spots and other small areas.



Part #	Fill Material	Trim	Rows	Block (L x W)	Brush Face (L x W)
◆ 9162CK	Hog bristle	15/16"	8 x 16	4-1/2" x 1-3/4"	4-1/4" x 1-1/2"
◆ 9162HH	Horse hair	15/16"	8 x 16	4-1/2" x 1-3/4"	4-1/4" x 1-1/2"
9162N	.012 Nylon	15/16"	8 x 16	4-1/2" x 1-3/4"	4-1/4" x 1-1/2"

Large Block Brushes

Large industrial brushes with hardwood handles, densely filled. The shorter 1/4" trim length is stiffer, for tougher scrubbing ability. The metal filled brushes are very effective at cleaning and deburring metal parts, as well as removing residue, metal filings, paint and coatings.



Part #	Fill Material	Trim	Rows	Block (L x W)	Brush Face (L x W)
426B	.012 Brass	1-3/4"	6 x 19	7-1/8" x 2-1/4"	6-1/2" x 1-3/4"
◆ 426CK	Hog bristle	3/4"	6 x 19	7-1/8" x 2-1/4"	6-5/8" x 1-7/8"
◆ 426CK-ST	Hog bristle	1/4"	6 x 19	7-1/8" x 2-1/4"	6-5/8" x 1-7/8"
426CS	.014 Carbon steel	1-3/4"	6 x 19	7-1/8" x 2-1/4"	6-1/2" x 1-3/4"
◆ 426HH	Horse hair	3/4"	6 x 19	7-1/8" x 2-1/4"	6-5/8" x 1-7/8"
◆ 426HH-ST	Horse hair	1/4"	6 x 19	7-1/8" x 2-1/4"	6-5/8" x 1-7/8"
426PB	.012 Phosphor bronze	1-3/4"	6 x 19	7-1/8" x 2-1/4"	6-1/2" x 1-3/4"
426SS	.012 Stainless steel	1-3/4"	6 x 19	7-1/8" x 2-1/4"	6-5/8" x 1-7/8"

◆ Anti-Static ▲ Static Dissipative ● Conductive

Long Block Brushes (Lag Brushes)

Staple set brushes available in a variety of lengths for scrubbing, washing, leveling, cushioning, etc.

Part #	Fill Material	Trim	Rows	Block (L x W)	Brush Face (L x W)
220-21	.018 Crimped polypropylene	3/4"	1 x 36	23" x 1"	22-1/2" x 1/4"
220-9	.018 Crimped polypropylene	3/4	1 x 47	30" x 1"	29-1/2" x 1/4"
220-6	.018 Crimped polypropylene	3/4"	1 x 56	36" x 1"	35-1/2" x 1/4"
220-5	.018 Crimped polypropylene	3/4"	1 x 76	48" x 1"	47-1/2" x 1/4"
220-2	.018 Crimped polypropylene	3/4"	1 x 95	60" x 1"	59-1/2" x 1/4"
220-4	.018 Crimped polypropylene	3/4"	1 x 101	64" x 1"	63-1/2" x 1/4"

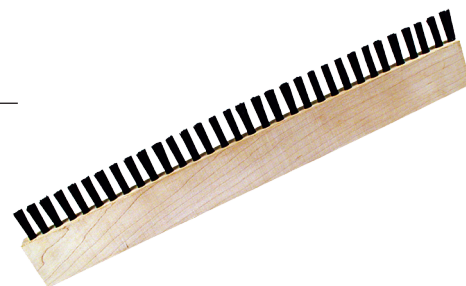

Small Upright Brushes

Two different styles that work well for getting into areas that are tight or at an unusual angle. WA12 style is also known as a keyboard brush. The brush part on the WB10 series is angled 30°.

Part #	Fill Material	Trim	Rows	Handle (L x W)	Brush Face (L x W)
WA12B	.006 Brass	1/2"	2 x 6	4-15/16" x 1-1/16"	7/8" x 3/8"
◆ WA12CK	Hog bristle	1/2"	2 x 6	4-15/16" x 1-1/16"	7/8" x 3/8"
◆ WA12HH	Horse hair	1/2"	2 x 6	4-15/16" x 1-1/16"	7/8" x 3/8"
◆ WA12HH-1	Horse hair	1"	2 x 6	4-15/16" x 1-1/16"	1" x 1/2"
WA12N	.012 Nylon	1/2"	2 x 6	4-15/16" x 1-1/16"	7/8" x 5/16"
WA12SS	.006 Stainless steel	1/2"	2 x 6	4-15/16" x 1-1/16"	7/8" x 5/16"
▲ WA12S9	.010 S.D. Nylon*	1/2"	2 x 6	4-15/16" x 1-1/16"	7/8" x 5/16"
◆ WB10CK	Hog bristle	1/2"	2 x 5	4-15/16" x 1-1/16"	7/8" x 3/8"
◆ WB10HH	Horse hair	1/2"	2 x 5	4-15/16" x 1-1/16"	1" x 3/8"
WB10CN	.020 Conductive Nylon	1/2"	2 x 5	4-15/16" x 1-1/16"	1" x 3/8"
WB10N	.012 Nylon	1/2"	2 x 5	4-15/16" x 1-1/16"	7/8" x 11/32"

* Static Dissipative Nylon (see page 2 for description)



Large Upright Brushes

Two longer, narrow shapes made with an upright hardwood handle, for dusting or cleaning. Also great for cleaning hard-to-reach areas.

Part #	Fill Material	Trim	Rows	Handle (L x W)	Brush Face (L x W)
◆ WA24CK	Hog bristle	1/2"	2 x 12	5-5/8" x 2"	1-3/4" x 11/32"
◆ WA24HH	Horse hair	1/2"	2 x 12	5-5/8" x 2"	1-3/4" x 3/8"
◆ WA68CK	Hog bristle	1"	3 x 22	5-5/8" x 6"	5-3/4" x 1/2"
◆ WA68HH	Horse hair	1"	3 x 22	5-5/8" x 6"	5-3/4" x 5/8"



Thunderon® Dusters/Static Dissipative Nylon Brushes

Thunderon® is a fine (very soft), conductive acrylic material specially made to clean or dust in areas that are sensitive to static electricity. It will dissipate a charge on any electrically charged surface. Thunderon® mixed with goat hair is slightly stiffer. Static dissipative nylon (S.D. Nylon) is an antistatic material used for light scrubbing applications near sensitive electronic circuitry or in potentially explosive environments. Black plastic handle is conductive, 3/8" thick.

Part #	Fill Material	Trim	Rows	Handle (L x W)	Brush Face (L x W)
▲ 900437ESD-010	.010 S.D. Nylon* (medium)	3/4"	1 x 22	4" x 1-1/4"	3-1/2" x 3/8"
▲ 900437ESD-016	.016 S.D. Nylon* (stiff)	3/4"	1 x 22	4" x 1-1/4"	3-1/2" x 3/8"
● 900437	Thunderon®/Goat	1-1/4"	1 x 22	4" x 1-1/4"	3-1/2" x 3/8"
● 900437T	Thunderon®	1-1/4"	1 x 22	4" x 1-1/4"	3-1/2" x 3/8"
▲ 900183ESD-010	.010 S.D. Nylon* (medium)	3/4"	1 x 29	9-3/4" x 7/8"	5-1/8" x 3/8"
▲ 900183ESD-016	.016 S.D. Nylon* (stiff)	3/4"	1 x 29	9-3/4" x 7/8"	5-1/8" x 3/8"
● 900183	Thunderon®/Goat	1-1/4"	1 x 29	9-3/4" x 7/8"	5-1/8" x 3/8"
● 900183T	Thunderon®	1-1/4"	1 x 29	9-3/4" x 7/8"	5-1/8" x 3/8"
● 900183L	Thunderon®/Goat	1-1/4"	1 x 54	16-3/4" x 7/8"	11" x 3/8"
● 900183TL	Thunderon®	1-1/4"	1 x 54	16-3/4" x 7/8"	11" x 3/8"

* Static Dissipative Nylon (see page 2 for description)

Orange Stick Brushes

Orange stick handle is chiseled on one end for small debris removal. Natural fill material includes soft goat hair, medium horse hair and stiff hog bristle. A great tool to clean or lightly scrape tiny areas.

Part #	Fill Material	Trim	Handle (L x D)	Brush Face Diameter
◆ WA7CK	Hog bristle	1/2"	7" x 3/16"	1/4"
◆ WA7G	Goat hair	1/2"	7" x 3/16"	1/4"
◆ WA7HH	Horse hair	1/2"	7" x 3/16"	1/4"



◆ Anti-Static ▲ Static Dissipative ● Conductive



Plastic Handle Scrub Brushes

Multi-purpose scrub brush with a raised molded handle provides an excellent grip, while keeping hands away from cleaning solutions. Highest quality nylon bristles are durable, resistant to alkalis and most solvents and heat tolerant to 230°F. Handle color will vary.

Part #	Fill Material	Trim	Rows	Brush Face (L x W)
906505	.022 Black nylon	1"	6 x 16	6" x 2-1/2"
Economy version for light to medium scrubbing:				
905505	.013 Crimped polypropylene	1"	7 x 13	6" x 2-1/2"



Wood Handle Counter Dusters

Fill material is staple set into a clear-lacquered hardwood handle, which has a hang-up hole.

Part #	Fill Material	Trim	Rows	Handle Length	Brush Face (L x W)
Soft for fine dusting:					
◆ CDHH	Horse hair	2-1/4"	5 x 15	13-1/2"	9-1/4" x 2-3/4"
CDFP	Flagged polystyrene	2-1/2"	5 x 15	13-1/2"	9" x 2-3/8"
Medium for general all-purpose cleaning:					
CDT	Black tampico	2-1/4"	5 x 15	14-1/4"	10" x 2-1/2"
7277	White tampico	2-1/4"	5 x 15	12-3/4"	9-1/2" x 2"
Heavy duty mill duster: designed with no side flare and a heavily filled front end for aggressive dusting. Very popular for cleaning metal chips in machine shops:					
CDHD	Brown polypropylene	1-3/4"	5 x 16	13"	8" x 1-3/4"



Plastic Handle Counter Dusters

Manufactured with structural foam polypropylene brush blocks.

Part #	Fill Material	Trim	Rows	Handle Length	Brush Face (L x W)
Soft for fine dusting:					
M550030	Horse hair	2-1/4"	5 x 15	13-1/2"	9-1/4" x 2-3/4"
M550090	Flagged styrene	2-1/4"	5 x 15	13-1/4"	9-1/4" x 3"
Medium for general all-purpose cleaning:					
M550080	Black polypropylene	2-1/4"	5 x 15	13-1/4"	9-1/4" x 3"
M550021	Blue polypropylene	2-1/4"	5 x 15	13-1/4"	9-1/4" x 3"
M550081	White polypropylene	2-1/4"	5 x 15	13-1/4"	9-1/4" x 3"
M550082	Red polypropylene	2-1/4"	5 x 15	13-1/4"	9-1/4" x 3"
M550083	Green polypropylene	2-1/4"	5 x 15	13-1/4"	9-1/4" x 3"
M550084	Yellow polypropylene	2-1/4"	5 x 15	13-1/4"	9-1/4" x 3"



T-Slot Brush

Easy-grip angled handle with a T-shaped scraper. An excellent tool for cleaning chips and dirt out of T-slots on machine tables. Polypropylene fill material will not absorb cutting fluids.

Part #	Fill Material	Trim	Rows	Handle (L x W)	Brush Face (L x W)
433PSC	.020 polypropylene	2"	3 x 11	8-7/8" x 7/8"	5-1/2" x 7/8"

Long Handle Dusting (Radiator) Brush

A long, narrow hardwood handle, filled with one row of tampico, has a flared tip to easily clean small crevices.

Part #	Fill Material	Trim	Rows	Handle (L x W)	Brush Face (L x W)
900622	Tampico	2"	1 x 30	24" x 3/8"	9-3/4" x 1/4"

◆ Anti-Static ▲ Static Dissipative ● Conductive

Instrument Cleaning Brushes

Designed for cleaning small areas, including instruments and pinpoint cleaning. Small tight head is mechanically clamped into a stainless steel tube and inserted into an acetal or static dissipative acetal handle.

Part #	Fill Material	Trim	Handle (L x D)	Overall Length	Brush Face (W)
906500CK	Hog bristle	3/16"	4" x 1/4"	5-3/4"	1/8"
906502CK	Hog bristle	3/16"	4" x 1/4"	Angled 5-1/2"	1/8"
906500HH	Horse hair	3/16"	4" x 1/4"	5-3/4"	1/8"
906502HH	Horse hair	3/16"	4" x 1/4"	Angled 5-1/2"	1/8"
906500	.003 Nylon	3/16"	4" x 1/4"	5-3/4"	3/16"
906503	.003 Nylon	3/16"	4" x 1/4"	Angled 5-1/2"	3/16"
▲ 906500SDX	.003 S.D. Nylon*	3/16"	4" x 1/4"	5-3/4"	3/16"
▲ 906503SDX	.003 S.D. Nylon*	3/16"	4" x 1/4"	Angled 5-1/2"	3/16"
906501	.003 Stainless steel	3/16"	4" x 1/4"	5-3/4"	3/16"
906502	.003 Stainless steel	3/16"	4" x 1/4"	Angled 5-1/2"	3/16"
▲ 906500S9X	.010 S.D. Nylon*	3/16"	4" x 1/4"	5-3/4"	3/16"
▲ 906503S9X	.010 S.D. Nylon*	3/16"	4" x 1/4"	Angled 5-1/2"	3/16"

* Static Dissipative Acetal Handle and Static Dissipative Nylon



Acid Brushes—Rolled Tin Handle

Disposable brushes for applying acid, glue, lubrication or coatings. Very popular when onetime usage is necessary.

Part #	Fill Material	Trim	Handle (L x W x D)	Brush Face (W)
◆ 900431	#00 Horse hair	1/2"	2-3/4" x 1/4" x 3/16"	5/16"
◆ AB4	#1 Horse hair	3/4"	5-1/4" x 3/8" x 1/4"	1/2"
AB4N	#1 Nylon	3/4"	5-1/4" x 3/8" x 1/4"	1/2"
◆ AB5	#2 Horse hair	13/16"	5-1/4" x 1/2" x 5/16"	1/2"
AB5N	#2 Nylon	13/16"	5-1/4" x 1/2" x 5/16"	1/2"
◆ AB8	#3 Horse hair	7/8"	5-1/4" x 9/16" x 3/8"	5/8"



Dome Dusters

Made with soft goat hair. Excellent for delicately removing dust and dirt without scratching delicate surfaces. Works well for lens cleaning.

Part #	Fill Material	Trim	Overall Length	Diameter	Size
◆ 0662-00050	Goat hair	1-1/8"	7-7/8"	3/4"	1/2"
◆ 0662-00075	Goat hair	1-3/8"	9-1/4"	1"	3/4"
◆ 0662-01000	Goat hair	1-1/2"	9-3/4"	1-1/2"	1"



Large Applicator (Dope) Brush

Wood handle with black horse hair fill material, firmly held by a metal ferrule. Inexpensive and commonly used for pipe dope, but also recommended for gluing, pasting, soldering and as a large acid brush.

Part #	Fill Material	Trim	Handle (L x D)	Brush Face (W)
◆ DB7	Horse hair	1-1/8"	7" x 1/2" (3/4" at crimp)	7/8"



Oval Sash Brushes

Oval shape works well for dusting and removing debris. Large plastic tapered handle has a metal ferrule.

Part #	Fill Material	Trim	Handle (L x D)	Size	Brush Face (W)
900046	Hog bristle	1-7/8"	9-1/2" x 3/4"	4	1-1/8"
900162	Hog bristle	2"	10-1/8" x 7/8"	6	1-1/4"
900744	Hog bristle	2"	10-1/2" x 1"	8	1-1/8"



Parts Cleaning Brushes

Standard parts cleaning brushes that work well for removing grease, oil and solvents from metal parts. Plastic tapered handle with metal ferrule.

Part #	Fill Material	Trim	Handle (L x D)	Brush Face Dia.
159999	.018 Crimped polypropylene	2-3/4"	7-3/4" x 1-1/16"	1-1/2"
159999CK	Hog bristle	2-1/4"	7-3/4" x 1-1/16"	1-1/2"
159999T	Tampico	3-1/4"	7-3/4" x 1-1/16"	1-1/2"



◆ Anti-Static ▲ Static Dissipative ● Conductive

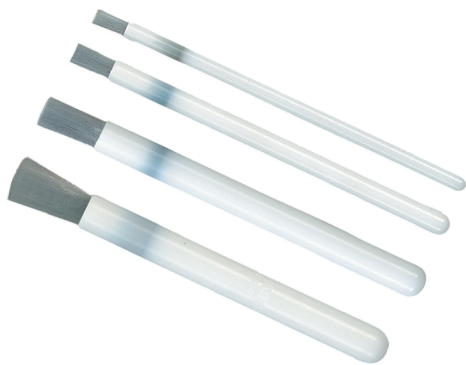

Applicator Brushes—Plastic Handle

Pencil-shaped applicator brush with either an acetal or static dissipative acetal handle. The NAD and S9X series are epoxy set with a high temperature adhesive that is autoclavable.

Part #	Fill Material	Trim	Handle (L x D)	Brush Face Diameter
187NP	.008 Nylon	3/8"	4-1/2" x 3/16"	3/16"
250NP	.008 Nylon	1/2"	4-1/2" x 1/4"	1/4"
375NP	.008 Nylon	3/4"	4-1/2" x 3/8"	3/8"
499NP	.008 Nylon	1"	4-1/2" x 1/2"	1/2"

Designed with high temperature adhesive that is autoclavable:

187NAD	.008 Nylon	3/8"	4-1/2" x 3/16"	3/16"
250NAD	.008 Nylon	1/2"	4-1/2" x 1/4"	1/4"
375NAD	.008 Nylon	3/4"	4-1/2" x 3/8"	3/8"
499NAD	.008 Nylon	1"	4-1/2" x 1/2"	1/2"
▲ 187S9X	.010 S.D. Nylon*	3/8"	4-1/2" x 3/16"	3/16"
▲ 250S9X	.010 S.D. Nylon*	1/2"	4-1/2" x 1/4"	1/4"
▲ 375S9X	.010 S.D. Nylon*	3/4"	4-1/2" x 3/8"	3/8"
▲ 499S9X	.010 S.D. Nylon*	1"	4-1/2" x 1/2"	1/2"

* Static Dissipative Acetal Handle and .010 Static Dissipative Nylon



Applicator Brushes—Zinc Plated Steel Handle

An inexpensive utility duster/cleaner that is an excellent replacement for disposable acid brushes that quickly shed fibers. Zinc plated steel handle holds the fibers in place with 5 tons of mechanical clamping and without any adhesives that could leach out and contaminate surface areas.

Part #	Fill Material	Trim	Handle (L x D)	Brush Face (W)
◆ 1CK	Hog bristle	3/4"	4-1/2" x 3/8"	5/8"
◆ 1HH	Horse hair	3/4"	4-1/2" x 3/8"	5/8"
1N	.010 Nylon	1"	4-1/2" x 3/8"	5/8"
▲ 1S9	.010 S.D. Nylon*	1"	4-1/2" x 3/8"	5/8"

* .010 Static Dissipative Nylon

Applicator Brushes—Aluminum Handle

Non-magnetic, lightweight aluminum handle. Constructed with strong mechanical clamping for maximum fiber retention, and contains no adhesives that can leach out and contaminate surface areas.

Part #	Fill Material	Trim	Handle (L x D)	Brush Face (W)
◆ AL251HH	Horse hair	1/2"	4" x 1/4"	1/2"
AL251N	.008 Nylon	1/2"	4" x 1/4"	1/2"
AL437N	.018 Nylon	1"	5" x 7/16"	3/8"

Applicator Brushes—Brass Handle

Various size brass tube applicator brushes to suit the demands your working environment dictates. All have strong mechanical fiber clamping for maximum fiber retention.

Part #	Fill Material	Trim	Handle (L x D)	Brush Face (W)
● BT201B	.003 Brass	1/8"	3-1/2" x 1/8"	3/16"
● BT202B	.003 Brass	3/8"	3-1/2" x 1/8"	3/16"
◆ BT202G	Goat hair	3/8"	3-1/2" x 1/8"	3/16"
◆ BT203G	Goat hair	1/2"	3-1/2" x 1/8"	1/4"
◆ BT201HH	Horse hair	1/8"	3-1/2" x 1/8"	3/16"
◆ BT204HH	Horse hair	11/16"	4" x 1/4"	7/16"
◆ BT146HH	Horse hair	3/4"	4" x 7/16"	3/4"
BT201N	.003 Nylon	1/8"	3-1/2" x 1/8"	3/16"
BT202N	.003 Nylon	3/8"	3-1/2" x 1/8"	3/16"
BT203N	.003 Nylon	1/2"	3-1/2" x 1/8"	1/4"
BT204N	.003 Nylon	11/16"	4" x 1/4"	7/16"
BT706N	.008 Nylon	1/2"	4" x 1/4"	3/8"
BT146N	.006 Nylon	3/4"	4" x 7/16"	3/4"
● BT406SS	.003 Stainless steel	5/16"	3-1/2" x 1/8"	1/8"
● BT407SS	.004 Stainless steel	3/8"	3-1/2" x 1/8"	1/8"
● BT606SS	.006 Stainless steel	3/8"	4" x 3/16"	3/16"
● BT706SS	.006 Stainless steel	1/2"	4" x 1/4"	1/4"

◆ Anti-Static ▲ Static Dissipative ● Conductive

Applicator Brushes—Double-Ended

Two sizes, one side has a short flat end, and the other end has an extra-stiff chiseled trim. Part #1005 series has a stainless steel handle. Part #1010 series has zinc plated handle. A great alternative to hand-trimming acid brushes.

Part #	Fill Material	Trim	Handle (L x D)	Brush Face (W)
◆ 1005CK	Hog bristle	1/4" Tapered, 1/2" Flat	4-1/2" x 3/16"	1/4" Flat
◆ 1005HH	Horse hair	1/4" Tapered, 1/2" Flat	4-1/2" x 3/16"	1/4" Flat
▲ 1005SD	.016 S.D. Nylon*	1/4" Tapered, 1/2" Flat	4-1/2" x 3/16"	1/4" Flat
▲ 1005S9	.010 S.D. Nylon*	1/4" Tapered, 1/2" Flat	4-1/2" x 3/16"	1/4" Flat
◆ 1010CK	Hog bristle	3/16" Tapered, 1/4" Flat	4-1/2" x 3/8"	1/2" Flat
◆ 1010HH	Horse hair	3/16" Tapered, 1/4" Flat	4-1/2" x 3/8"	1/2" Flat
1010N	.010 Nylon	3/16" Tapered, 1/4" Flat	4-1/2" x 3/8"	1/2" Flat
1010SB	.003 Brass/Sponge	1/2"	4-1/2" x 3/8"	7/16"
▲ 1010SD	.016 S.D. Nylon*	3/16" Tapered, 1/4" Flat	4-1/2" x 3/8"	1/2" Flat
▲ 1010S9	.010 S.D. Nylon*	3/16" Tapered, 1/4" Flat	4-1/2" x 3/8"	1/2" Flat

* Static Dissipative Nylon



Applicator Brushes—Stainless Handle

Stainless steel handle for excellent chemical resistance. Manufactured using strong mechanical fiber clamping for maximum fiber retention.

Part #	Fill Material	Trim	Max Use	Handle (L x D)	Brush Face (W)
● SST2B	.003 Brass	1/8"	500° F	3-1/2" x 1/8"	3/16"
● SST6B	.003 Brass	5/16"	500° F	4-1/2" x 3/16"	5/16"
● SST10B	.003 Brass	1/2"	500° F	4-3/4" x 5/16"	7/16"
● SST12B	.003 Brass	1/2"	500° F	6" x 3/8"	1/2"
◆ SST2G	Goat hair	1/8"	300° F	3-1/2" x 1/8"	3/16"
◆ SST6G	Goat hair	5/16"	300° F	4-1/2" x 3/16"	5/16"
◆ SST10G	Goat hair	3/8"	300° F	4-3/4" x 5/16"	1/2"
◆ SST12G	Goat hair	3/4"	300° F	6" x 3/8"	1/2"
◆ SST2CK	Hog bristle	1/8"	380° F	3-1/2" x 1/8"	3/16"
◆ SST6CK	Hog bristle	5/16"	380° F	4-1/2" x 3/16"	5/16"
◆ SST10CK	Hog bristle	3/8"	380° F	4-3/4" x 5/16"	3/8"
◆ SST12CK	Hog bristle	3/4"	380° F	6" x 3/8"	1/2"
◆ SST2HH	Horse hair	1/8"	370° F	3-1/2" x 1/8"	3/16"
◆ SST6HH	Horse hair	5/16"	370° F	4-1/2" x 3/16"	5/16"
◆ SST7HH	Horse hair	3/8"	370° F	3-1/2" x 3/16"	5/16"
◆ SST10HH	Horse hair	3/8"	370° F	4-3/4" x 5/16"	1/2"
◆ SST12HH	Horse hair	3/4"	370° F	6" x 3/8"	1/2"
SST2N	.003 Nylon	1/8"	250° F	3-1/2" x 1/8"	3/16"
SST6N	.008 Nylon	5/16"	250° F	4-1/2" x 3/16"	5/16"
SST7N	.008 Nylon	3/8"	250° F	3-1/2" x 3/16"	5/16"
SST10N	.008 Nylon	3/8"	250° F	4-3/4" x 5/16"	1/2"
SST12N	.008 Nylon	3/4"	250° F	6" x 3/8"	1/2"
SST2P	.006 PEEK	1/8"	480° F	3-1/2" x 1/8"	3/16"
SST6P	.006 PEEK	5/16"	480° F	4-1/2" x 3/16"	5/16"
SST10P	.006 PEEK	3/8"	480° F	4-3/4" x 5/16"	1/2"
SST12P	.006 PEEK	3/4"	480° F	6" x 3/8"	1/2"
SST2PP	.008 Polypropylene	1/8"	225° F	3-1/2" x 1/8"	3/16"
SST6PP	.008 Polypropylene	5/16"	225° F	4-1/2" x 3/16"	5/16"
SST10PP	.008 Polypropylene	3/8"	225° F	4-3/4" x 5/16"	1/2"
SST12PP	.008 Polypropylene	3/4"	225° F	6" x 3/8"	1/2"
● SST2SS	.003 Stainless steel	1/8"	900° F	3-1/2" x 1/8"	3/16"
● SST6SS	.003 Stainless steel	5/16"	900° F	4-1/2" x 3/16"	5/16"
● SST10SS	.003 Stainless steel	1/2"	900° F	4-3/4" x 5/16"	5/16"
● SST12SS	.003 Stainless steel	1/2"	900° F	6" x 3/8"	1/2"
● 146644	.006 Stainless steel	5/8"	900° F	5-3/8" x 3/8"	3/8"
▲ SST2S9	.010 S.D. Nylon*	1/8"	225° F	3-1/2" x 1/8"	3/16"
▲ SST6S9	.010 S.D. Nylon*	5/16"	225° F	4-1/2" x 3/16"	5/16"
▲ SST10S9	.010 S.D. Nylon*	3/8"	225° F	4-3/4" x 5/16"	1/2"
▲ SST12S9	.010 S.D. Nylon*	3/4"	225° F	6" x 3/8"	1/2"
SST6TEF	.011 PTFE	1/2"	400° F	4-1/2" x 3/16"	5/16"
SST10TEF	.011 PTFE	1/2"	400° F	4-3/4" x 5/16"	1/2"
SST12TEF	.011 PTFE	3/4"	400° F	6" x 3/8"	3/4"
● SST2T	Thunderon®	1/8"	3-1/2" x 1/8"	3/16"	
● SST6T	Thunderon®	5/16"	4-1/2" x 3/16"	5/16"	
● SST10T	Thunderon®	3/8"	4-3/4" x 5/16"	1/2"	
● SST12T	Thunderon®	3/4"	6" x 3/8"	3/4"	

* .010 Static Dissipative Nylon

◆ Anti-Static ▲ Static Dissipative ● Conductive

Fitch Black Bristle Brushes

Black bristle brushes with an angular fitch shape, halfway between a round and a flat. Long natural wood handle allows a good working distance.

Part #	Trim	Size	Overall Length	Brush Face (W)
◆ 0987-00025	7/8"	1/4"	11-1/2"	3/8"
◆ 0987-00037	1"	3/8"	11-1/2"	3/8"
◆ 0987-00050	1-1/8"	1/2"	12-3/8"	5/8"
◆ 0987-00062	1-1/2"	5/8"	12-3/8"	3/4"
◆ 0987-00075	1-1/2"	3/4"	12-1/2"	1"
◆ 0987-01000	1-1/2"	1"	12-1/2"	1"
◆ 0987-01050	2"	1-1/2"	12-1/2"	1-3/4"

Black Bristle Marking Brushes

Fine-quality, black bristle marking brushes with wood handles for general marking or touch-up.

Part #	Trim	Size	Overall Length	Diameter
◆ 6206-01000	5/8"	1	11-1/4"	.160"
◆ 6206-02000	3/4"	2	11-1/4"	.188"
◆ 6206-03000	7/8"	3	11-3/4"	.201"
◆ 6206-04000	1"	4	11-3/4"	.231"
◆ 6206-05000	1"	5	12-1/4"	.245"
◆ 6206-06000	1-1/8"	6	12-1/4"	.285"

Round White Bristle Brushes

Round white bristle brushes with long lacquered wood handles and seamless nickel-plated ferrules.

Part #	Trim	Size	Overall Length	Diameter
◆ 0316-02000	3/4"	2	11-1/2"	.177"
◆ 0316-04000	7/8"	4	12-1/4"	.217"
◆ 0316-06000	1"	6	12-3/8"	.310"
◆ 0316-08000	1-1/4"	8	12-1/2"	.394"
◆ 0316-10000	1-1/2"	10	13-1/2"	.433"
◆ 0316-12000	1-3/4"	12	13-1/2"	.551"

White Taklon Round Brushes

White taklon brushes are recognized for their versatility and durability. Round shaped head, nickel plated ferrule and a lacquered handle.

Part #	Trim	Size	Overall Length	Diameter
0036-00300	1/4"	3/0	7"	.065"
0036-00200	1/4"	2/0	7"	.069"
0036-00200P	1/4"	2/0	7"	.069"
0036-00000	5/16"	0	7"	.081"
0036-00000P	5/16"	0	7"	.081"
0036-01000	3/8"	1	7"	.088"
0036-02000	7/16"	2	7"	.102"
0036-04000	1/2"	4	7-1/2"	.137"
0036-06000	5/8"	6	7-1/2"	.150"
0036-08000	3/4"	8	7-3/4"	.220"
0036-10000	3/4"	10	7-3/4"	.238"

White Taklon Flat Brushes

Durable flat brushes made with the finest white taklon, a nickel-plated ferrule and a lacquered handle.

Part #	Trim	Size	Overall Length	Brush Face (W)
0037-02000	.275"	2	7"	1/8"
0037-04000	.354"	4	7"	3/16"
0037-06000	.492"	6	7-1/2"	1/4"
0037-08000	.629"	8	7-3/4"	5/16"
0037-10000	.669"	10	8"	3/8"

Pony Hair Round Brushes

Inexpensive disposable pony hair brush with a black plastic handle.

Part #	Trim	Size	Overall Length	Diameter
◆ 6021-01000	3/8"	1	7"	.078"
◆ 6021-02000	3/8"	2	7"	.094"
◆ 6021-03000	1/2"	3	7"	.125"
◆ 6021-05000	9/16"	5	7"	.166"
◆ 6021-06000	5/8"	6	7"	.177"

Camel Hair Round Brushes

Great wood handle detail brush that is terrific for painting, adhesive applications and general touch-up work. Wide variety of sizes available.

Part #	Trim	Size	Overall Length	Diameter
◆ 6020-01000	3/8"	1	7"	.078"
◆ 6020-02000	3/8"	2	7"	.094"
◆ 6020-03000	7/16"	3	7"	.125"
◆ 6020-04000	1/2"	4	7-3/8"	.158"
◆ 6020-05000	9/16"	5	7-3/8"	.166"
◆ 6020-06000	5/8"	6	7-3/8"	.177"
◆ 6020-07000	3/4"	7	7-3/8"	.186"
◆ 6020-08000	7/8"	8	7-3/8"	.197"
◆ 6020-09000	7/8"	9	7-5/8"	.215"
◆ 6020-10000	1"	10	8-1/4"	.236"
◆ 6020-11000	1"	11	8-1/4"	.240"
◆ 6020-12000	1"	12	8-1/4"	.260"

Camel Hair Flat Brushes

Camel hair flat brush with a natural wood handle. Works well for dusting parts and applying paint, adhesives and a wide variety of touch-up work.

Part #	Trim	Size	Overall Length	Brush Face (W)
◆ 0790-00012	1/4"	1/8"	6-5/8"	1/4"
◆ 0790-00025	7/16"	1/4"	6-5/8"	5/16"
◆ 0790-00037	1/2"	3/8"	7"	3/8"
◆ 0790-00050	5/8"	1/2"	7-3/8"	1/2"
◆ 0790-00062	3/4"	5/8"	7-1/2"	5/8"
◆ 0790-00075	1"	3/4"	7-1/2"	7/8"
◆ 0790-01000	1-1/4"	1"	7-3/4"	1-1/8"
◆ 0790-01050	1-3/8"	1-1/2"	8"	1-3/4"

Gold Taklon Round Brushes

The perfect round brush, great for sign painting, striping and detailing work, with a full body and a fine tip. Lacquered wood handle with a seamless ferrule.

Part #	Trim	Size	Overall Length	Diameter
0865-00100	1/2"	10/0	7-1/8"	.025"
0865-00300	21/32"	3/0	7-3/8"	.048"
0865-01000	7/8"	1	7-7/16"	.065"
0865-02000	15/16"	2	7-7/16"	.065"
0865-03000	1-1/16"	3	7-3/4"	.075"
0865-04000	1-3/32"	4	8-1/8"	.075"
0865-06000	1-5/32"	6	8-3/8"	.135"

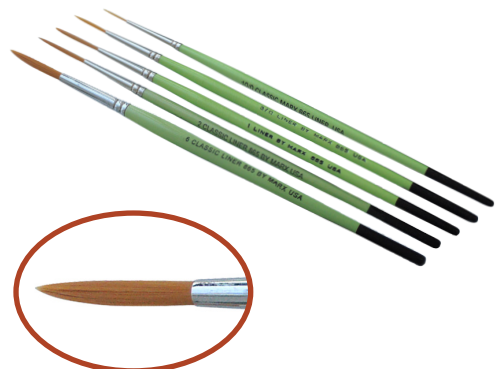

◆ Anti-Static ▲ Static Dissipative ● Conductive

Red Sable Round Brushes

Round Red Sable brush is more economical than pure red sable and can be used for similar applications.



Part #	Trim	Size	Overall Length	Diameter
◆ 0770-00300	.236"	3/0	7"	.067"
◆ 0770-00000	.295"	0	7"	.070"
◆ 0770-01000	.354"	1	7"	.077"
◆ 0770-02000	.433"	2	7"	.079"
◆ 0770-03000	.511"	3	7-3/8"	.098"
◆ 0770-04000	.532"	4	7-3/8"	.104"
◆ 0770-06000	.625"	6	7-3/8"	.162"
◆ 0770-08000	.794"	8	7-3/8"	.198"
◆ 0770-10000	.860"	10	8"	.230"

Red Sable Flat Brushes

Traditional flat brush for applying paints and other liquids to a flat, wide area. Also good for general cleaning. Made with red sable.



Part #	Trim	Size	Overall Length	Brush Face (W)
◆ 0611-02000	1/4"	2	7"	1/8"
◆ 0611-04000	3/8"	4	7"	3/16"
◆ 0611-06000	7/16"	6	7-1/4"	1/4"
◆ 0611-08000	7/16"	8	7-1/2"	3/8"
◆ 0611-10000	1/2"	10	7-1/2"	7/16"
◆ 0611-12000	9/16"	12	7-5/8"	5/8"

Pure Red Sable Fine Detail Brushes

Round-shaped brush head in small sizes, excellent for applying paint, epoxy, glue, or other liquids to tiny, hard-to-reach areas. Also great for cleaning detailed parts. Made with pure red sable hair.



Part #	Trim	Size	Overall Length	Diameter
◆ 6999-00100	.013"	10/0	6-3/4"	.039"
◆ 6999-00800	.275"	8/0	6-3/4"	.078"
◆ 6999-00600	.196"	6/0	6-3/4"	.074"
◆ 6999-00400	.234"	4/0	6-3/4"	.076"
◆ 6999-00200	.275"	2/0	6-3/4"	.078"

Pure Red Sable Round Brushes

Traditional round brush made out of pure red sable hair, which is softer than camel hair, pony hair and bristle. Ideal for applying oils, acrylics and less caustic solutions. Great for applications where detail is important when working on a larger surface area.



Part #	Trim	Size	Overall Length	Diameter
◆ 0906-00300	.236"	3/0	7"	.067"
◆ 0906-00000	.295"	0	7"	.070"
◆ 0906-01000	.345"	1	7"	.077"
◆ 0906-02000	.433"	2	7"	.079"
◆ 0906-03000	.511"	3	7-3/8"	.098"
◆ 0906-04000	.532"	4	7-3/8"	.104"
◆ 0906-05000	.590"	5	7-3/8"	.136"
◆ 0906-06000	.625"	6	7-3/8"	.162"
◆ 0906-07000	.748"	7	7-3/8"	.184"
◆ 0906-08000	.794"	8	7-1/2"	.198"
◆ 0906-10000	.860"	10	8"	.230"
◆ 0906-12000	1"	12	8"	.265"

Chemical Resistant—Pure Red Sable Round Brushes

Pure red sable hair, ideal for applying conformal coatings. This brush is made to endure harsh chemicals, including toluene, without deterioration. Unvarnished hardwood handle, so chemicals will not cause paint to peel or flake.

Part #	Trim	Size	Overall Length	Diameter
◆ 0907-00300	.236"	3/0	7"	.067"
◆ 0907-00000	.295"	0	7"	.070"
◆ 0907-01000	.345"	1	7"	.077"
◆ 0907-02000	.433"	2	7"	.079"
◆ 0907-03000	.511"	3	7-3/8"	.098"
◆ 0907-04000	.532"	4	7-3/8"	.104"
◆ 0907-05000	.590"	5	7-3/8"	.136"
◆ 0907-06000	.625"	6	7-3/8"	.162"
◆ 0907-08000	.794"	8	7-1/2"	.198"

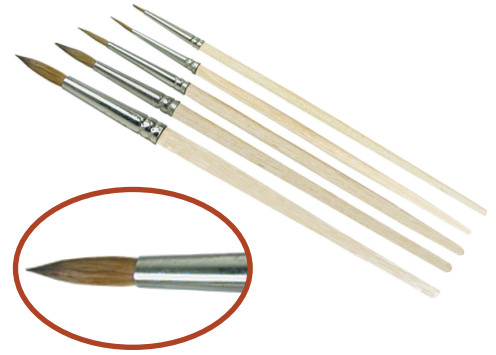

Chemical Resistant—Ox Hair Flat Brushes

Long ox hair stroke brush is made to withstand harsh chemicals, including toluene, without deterioration. Use in a variety of applications where flat, even application is needed. Ideal for applying conformal coatings. Unvarnished hardwood handle, so chemicals will not cause paint to peel or flake.

Part #	Trim	Size	Overall Length	Brush Face (W)
◆ 0689-00012	5/8"	1/8"	7-1/2"	1/4"
◆ 0689-00025	3/4"	1/4"	7-1/2"	1/4"
◆ 0689-00037	7/8"	3/8"	7-3/4"	5/8"
◆ 0689-00050	1"	1/2"	7-3/4"	3/4"
◆ 0689-00075	1-3/8"	3/4"	9"	1"
◆ 0689-01000	1-1/2"	1"	9"	1-1/4"



Stencil Brushes

Hog bristle brush for working with inks, stencils and other marking applications. Seamless nickel-plated ferrule in a hardwood handle.

Part #	Trim	Size	Overall Length	Diameter
◆ 1501-02000	1/2"	2	5-1/2"	.236"
◆ 1501-04000	3/4"	4	5-3/4"	.315"
◆ 1501-06000	3/4"	6	5-7/16"	.354"
◆ 1501-08000	7/8"	8	6"	.487"
◆ 1501-10000	1-1/8"	10	6-1/2"	.680"



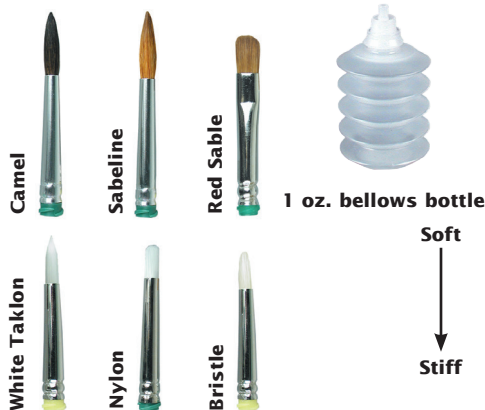

Flow-Thru Luer Lock Brushes

A stainless steel flow-thru needle with a luer lock base, inserted into a nickel-plated ferrule. Six different brush materials that range from soft to stiff are available with three different needle gauges. Other sizes are available upon request.

Fill Material	Dia.	Trim	Needle Gauge, Inside Diameter, Part #		
			16 (.053)	18 (.038)	22 (.019)
Camel	3/16"	7/16"	FTC-16	FTC-18	FTC-22
Sabeline	3/16"	3/4"	FTSL-16	FTSL-18	FTSL-22
Red sable	3/16"	7/16"	FTRS-16	FTRS-18	FTRS-22
White taklon	5/16"	7/16"	FTWT-16	FTWT-18	FTWT-22
Nylon	3/16"	13/16"	FTN-16	FTN-18	FTN-22
Bristle	3/16"	5/8"	FTHB-16	FTHB-18	FTHB-22

Part #	Description
BTL-BEL-1	1 oz. bellows bottle with luer lock insert fits any of the above luer lock brushes.

Small Flow-Thru Parts Wash Brushes

Solvent resistant, micro-sized nylon tubes are mixed with nylon, brass or stainless steel for light, moderate, or aggressive cleaning. Stainless handle easily connects to a standard parts wash hose.

Nylon: For all purpose cleaning. Great for small parts.

Brass: Use to remove light to medium corrosion or dirt from soft metals such as gold, brass, aluminum, etc. Will not damage most metal finishes.

Stainless: Use to remove medium to heavy corrosion from steel, titanium or other hard metal surfaces.

Part #	Fill Material	Trim	Handle (L x D)	Brush Face (W)
PC12N	.018 Nylon	1/2"	4-1/2" x 3/8"	1/2"
PC12B	.010 Brass/.018 Nylon	1/2"	4-1/2" x 3/8"	1/2"
PC12SS	.010 Stainless steel/.018 Nylon	1/2"	4-1/2" x 3/8"	1/2"

Flow-Thru Solvent Applicator, Slip On Style

Part #	Fill Material	Trim	Handle Size	Housing Diameter	Housing Material	Brush Face
900982	Hog Bristle	1/2"	1-1/2"	0.45	Acetal	Ø9/32"
900982N	.010 Natural Level Nylon	1/2"	1-1/2"	0.45	Acetal	Ø9/32"
▲900982SDN	.010 Yellow Level SDN*	1/2"	1-1/2"	0.45	Acetal	Ø9/32"

*Static Dissipative Nylon

Flow-Thru Lubrication/Applicator Brushes with 1/8" Pipe Threads

These high volume flow-thru brushes have an aluminum body and can be used in robotic and non-robotic applications. The bristles are held in with chemical resistant glue. Use nylon for adhesives, petroleum distillates, and solvents (maximum use temp 250°F). Use polypropylene for water, alcohols, and acids (maximum use temp 200°F). Use horse hair to apply paints, lubricants, and sealers (maximum use temp 370°F). Use stainless steel for harsh environments or to simultaneously clean and apply (maximum use temp 500°F).

Part #	Fill Material	Trim	Body Dia.	Body Length	Orifice Size	Thread
LBM-5NY	.010 Black level nylon	1-5/16"	5/8"	1"	.125"	1/8" NPT Male
LBM-5PP	.008 Black level polypropylene	1-5/16"	5/8"	1"	.125"	1/8" NPT Male
◆LBM-5HH	Black horse hair	1-5/16"	5/8"	1"	.125"	1/8" NPT Male
●LBM-5SS	.005 Crimped stainless steel	1-5/16"	5/8"	1"	.125"	1/8" NPT Male
LBM-8NY	.010 Black level nylon	1-5/16"	1"	1"	.125"	1/8" NPT Male
LBM-8PP	.008 Black level polypropylene	1-5/16"	1"	1"	.125"	1/8" NPT Male
◆LBM-8HH	Black horse hair	1-5/16"	1"	1"	.125"	1/8" NPT Male
●LBM-8SS	.005 Crimped stainless steel	1-5/16"	1"	1"	.125"	1/8" NPT Male
LBF-5NY	.010 Black level nylon	1"	5/8"	7/8"	.125"	1/8" NPS Female
LBF-5PP	.008 Black level polypropylene	1"	5/8"	7/8"	.125"	1/8" NPS Female
◆LBF-5HH	Black horse hair	1"	5/8"	7/8"	.125"	1/8" NPS Female
●LBF-5SS	.005 Crimped stainless steel	1-1/4"	5/8"	7/8"	.125"	1/8" NPS Female
LBF-9NY	.010 Black level nylon	1"	1-1/8"	1-1/8"	.156"	1/8" NPS Female
LBF-9PP	.008 Black level polypropylene	1"	1-1/8"	1-1/8"	.156"	1/8" NPS Female
◆LBF-9HH	Black horse hair	1"	1-1/8"	1-1/8"	.156"	1/8" NPS Female
●LBF-9SS	.005 Crimped stainless steel	1-1/4"	1-1/8"	1-1/8"	.156"	1/8" NPS Female

◆ Anti-Static ▲ Static Dissipative ● Conductive

Specialty End Brushes

Steel body is 1-5/8" long. Shank is 13/16" long and has a 1/4" diameter. Brush diameter is 1".

Part #	Fill Material	Trim	Use
◆ EB14HH	Horse hair	1"	Polishing
EB14P	.016 PEEK	1"	High temperatures (480°F)
▲ EB14SD*	.016 S.D. Nylon*	1"	Static sensitive cleaning and polishing
EB14T	Tampico	1"	Cleaning steel/aluminum molds
● EB14TI	.008 Titanium	1"	Cleaning titanium (no corrosion)
● EB14 SS6	.006 Stainless steel	1"	Cleaning & deburring

*Static Dissipative Nylon

Miniature Vacuum Brushes

Angled vacuum head with a 7" handle for small or difficult to reach areas. Available with an acetal or static dissipative acetal handle.

Acetal Body:

Part #	Fill Material	Trim	Inlet Dia.	Head Dia.
900488GH	Goat hair	1/4"	1/4"	7/8"
900488	Horse hair	1/4"	1/4"	7/8"
900488N	.004 Nylon	1/4"	1/4"	7/8"

Static Dissipative Acetal Body:

▲ 900488SD*	.010 S.D. Nylon*	1/4"	1/4"	7/8"
● 900488T	.0015 Thunderon®	1/4"	1/4"	7/8"

*Static Dissipative Nylon

Acid Resistant Vacuum Brushes

Polypropylene body, filled with polypropylene and hand tied with polypropylene monofilament; for use in corrosive environments. Brush fits standard 3/4" OD at 5/8" ID.

Part #	Fill Material	Trim	Inlet Dia.	Head Dia.
901744PK	.006 PEEK	1/2"	5/8"	2-1/2"
901744PP	.006 Polypropylene	1/2"	5/8"	2-1/2"

Anti-Static Vacuum Brush

Standard molded plastic vacuum head with a grounding point, providing electrical continuity to the static dissipative filament. Use in static sensitive areas. Brush fits standard 1-1/4" tapered hose.

Part #	Fill Material	Trim	Inlet Dia.	Head Dia.
▲ 901350-016SD*	.016 S.D. Nylon*	1"	1"	2-1/2"

*Static Dissipative Nylon

Heavy Duty Vacuum Brushes

Aluminum body with hand tied durable fill materials; for harsh environments, high temperatures and static-sensitive areas. Fits standard 1-1/4" tapered hose.

Part #	Fill Material	Trim	Inlet Dia.	Head Dia.
● 901336-010BR	.010 Brass	2"	1-1/4"	3-1/4"
901336-016PK	.016 PEEK	2"	1-1/4"	3-1/4"
▲ 901336-016SD*	.016 S.D. Nylon*	2"	1-1/4"	3-1/4"
● 901336-010SS	.010 Stainless	2"	1-1/4"	3-1/4"

*Static Dissipative Nylon



◆ Anti-Static ▲ Static Dissipative ● Conductive

ALUMINUM CHANNEL HOLDERS

Aluminum strip brush holders in two standard styles. Other styles are available upon request.

#2.5 Channel Holders

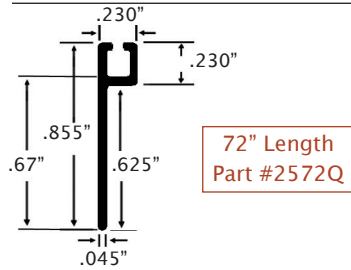

72" Length
Part #2572Q

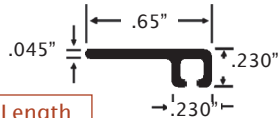

72" Length
Part #2572D

#4 Channel Holders

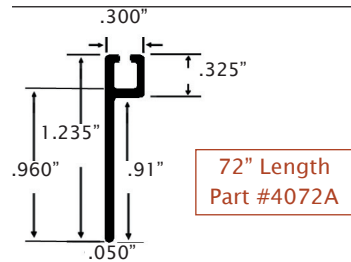

72" Length
Part #4072A

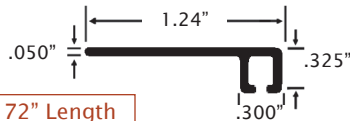

72" Length
Part #4072C

STAINLESS STEEL CHANNEL HOLDERS

#4 Channel Holders

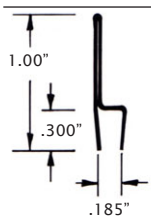

72" Length
Part #4072SS



#2.5 Backing Strip Brushes

Galvanized steel channel, 72" overall length
1/8" x 1/8"

Part #	Fill Material	Overall Height
23105	.006 Crimped black nylon	1/2"
23106	.010 Crimped black nylon	1.5"
23112	.006 Black polypropylene	5/8"
23113	.006 Black polypropylene	7/8"
23114	.006 Black polypropylene	1-1/8"
23115	.006 Black polypropylene	1-5/8"
23116	.006 Black polypropylene	2-1/8"

#4 Backing Strip Brushes

Stainless steel channel, 72" overall length
3/16" x 3/16"

Part #	Fill Material	Overall Height
● 44775	.004 Crimped brass	1"
● 44776	.006 Crimped brass	2"
● 44777	.008 Crimped brass	3"
23134	.010 Crimped black nylon	1"
23135	.010 Crimped black nylon	2"
23137	.014 Crimped black nylon	3"
23138	.014 Crimped black nylon	4"
23139	.014 Crimped black nylon	6"
● 44755	.004 Stainless steel	1"
● 44756	.006 Stainless steel	2"
● 44757	.008 Stainless steel	3"
● 44758	.006 Stainless steel	4"
● 44759	.008 Stainless steel	6"

Galvanized steel channel, 72" overall length
3/16" x 3/16"

Part #	Fill Material	Overall Height
◆ 23146	Black horse hair	3/4"
◆ 23147	Black horse hair	1-1/4"
◆ 23148	Black horse hair	2"
● 44962	.010 Black 100% conductive nylon	1"
● 44963	.010 Black 100% conductive Nylon	2"
● 44964	.010 Black 100% conductive Nylon	3"
◆ 44950	.010 Yellow anti-static Nylon	1"
◆ 44951	.010 Yellow anti-static Nylon	2"
◆ 44952	.010 Yellow anti-static Nylon	3"
23122	.010 Crimped black Nylon	1"
23123	.010 Crimped black Nylon	2"
23124	.014 Crimped black Nylon	3"
23125	.014 Crimped black Nylon	4"
23126	.014 Crimped black Nylon	6"
23171	.006 Black polypropylene	11/16"
23172	.006 Black polypropylene	15/16"
23173	.006 Black polypropylene	1-3/16"
23174	.006 Black polypropylene	1-11/16"
23175	.006 Black polypropylene	1-15/16"
23176	.006 Black polypropylene	2-3/16"
23177	.006 Black polypropylene	2-11/16"
23178	.010 Crimped black polypropylene	3-3/16"
23182	White tampico	3/4"
23183	White tampico	1-1/4"
23184	White tampico	2"

Additional strip brush sizes and styles are available by request. Find a design sheet at www.gordonbrush.com/stripbrushes_rfq.php or go to page 24.

#2.5 Strip Brush Measurements

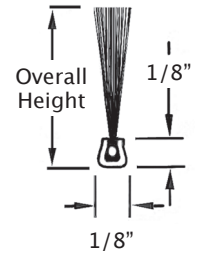

#4 Strip Brush Measurements

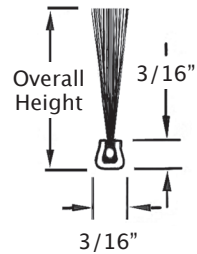

#7 Backing Strip Brushes

Galvanized steel channel, 72" overall length
5/16" x 5/16"

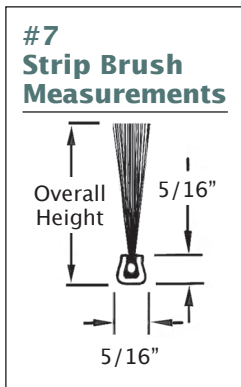

Part #	Fill Material	Overall Height
23190	.010 Crimped black nylon	1"
23191	.014 Crimped black nylon	2"
23192	.014 Crimped black nylon	3"
23193	.020 Crimped black nylon	4"
23194	.020 Crimped black nylon	6"
80998	.045 Crimped black nylon	6"
◆ 23208	Black horse hair	1"
◆ 23209	Black horse hair	2"
◆ 23210	Black horse hair	3"
23214	White tampico	1"
23215	White tampico	2"
23216	White tampico	3"

Stainless steel channel, 72" overall length 5/16" x 5/16"

Part #	Fill Material	Overall Height
● 44765	.006 Stainless steel	1"
● 44766	.010 Stainless steel	2"
● 44767	.014 Stainless steel	3"
● 44768	.010 Stainless steel	4"
● 44769	.014 Stainless steel	6"
23200	.010 Crimped black nylon	1"
23201	.014 Crimped black nylon	2"
23202	.014 Crimped black nylon	3"
23203	.020 Crimped black nylon	4"
23204	.020 Crimped black nylon	6"
● 44785	.006 Brass	1"
● 44786	.010 Brass	2"
● 44787	.014 Brass	3"
● 44788	.010 Brass	4"
● 44789	.014 Brass	6"

#10 Backing Strip Brushes

Galvanized steel channel, 72" overall length
7/16" x 7/16"

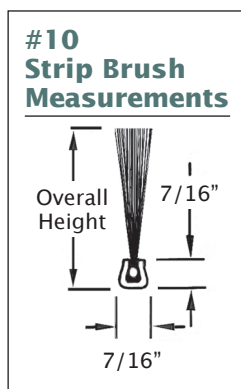

Part #	Fill Material	Overall Height
23222	.014 Crimped black nylon	2"
23223	.020 Crimped black nylon	3"
23224	.020 Crimped black nylon	4"
23225	.030 Crimped black nylon	5"
23226	.050" Crimped black nylon	6"

Additional strip brush sizes and styles are available by request.
Find a design sheet at
www.gordonbrush.com/stripbrushes_rfq.php
or go to page 24.

ALUMINUM CHANNEL HOLDERS

Aluminum strip holders in two standard styles. Other styles are available upon request.

#7 Channel Holders

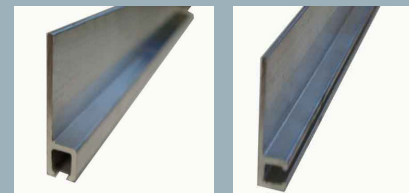
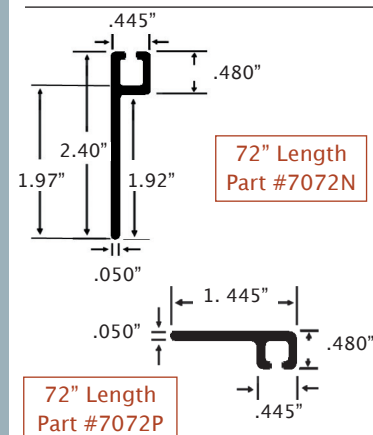

STAINLESS STEEL CHANNEL HOLDERS

#7 Channel Holders

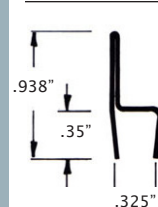

#10 Channel Holders

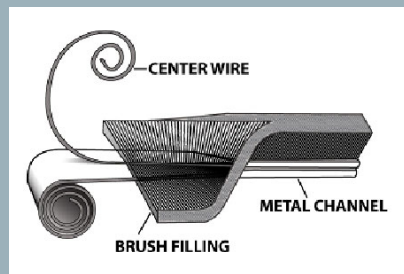
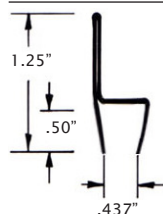

STRIP BRUSHES DESIGN SHEET

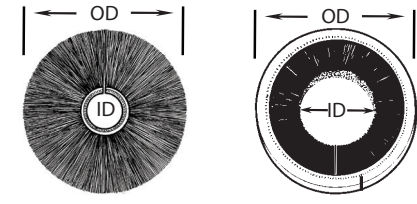
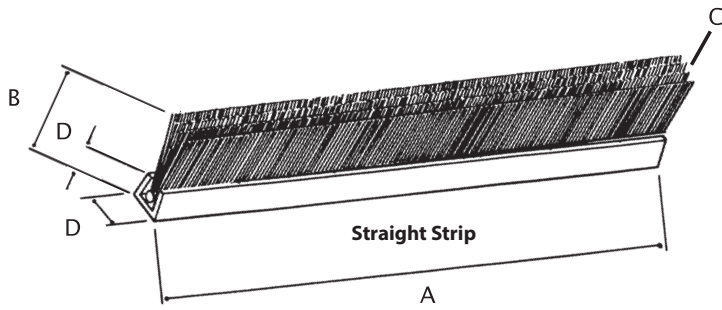

Outward Wound Disk Inward Wound Disk

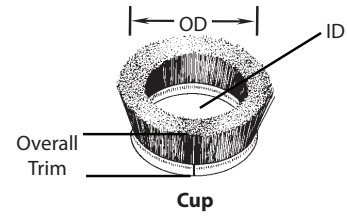

Overall Trim
Cup

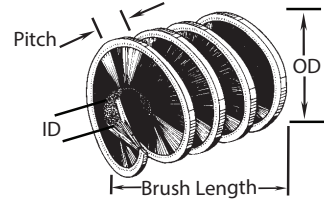

Inward Wound Spiral/Coil

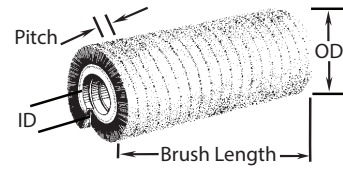

Outward Wound Spiral/Coil

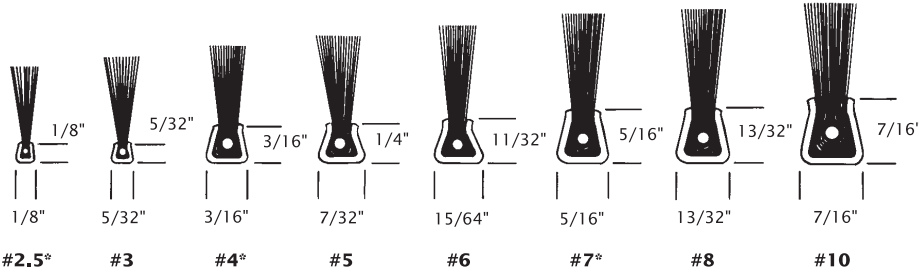

*MOST POPULAR SIZES

HOLDERS FOR STRIP BRUSHES (OPTIONAL)
circle appropriate style



Right Angle Center Mount Angled Flange



Right Angle Flange Straight Flange

A. Brush Length _____

B. Overall Trim Length _____

C. Fill Material Type _____

(Nylon, Polypropylene, Horse Hair, Carbon Steel, Stainless Steel, Brass, Tampico, Phosphor Bronze, Antistatic Nylon, Polyester, Conductive Nylon, Thunderon ® etc...)

Fill (Bristle) Diameter _____

Fill (Bristle) Color _____

Fill Style:

Crimped (Wavy) Level (Straight)

D. Metal Channel Size #

(#4 and #7 are most common)

width x height

- #2.5 1/8" x 1/8"
- #3 5/32" x 5/32"
- #4 3/16" x 3/16"
- #5 7/32" x 1/4"
- #6 15/64" x 11/32"
- #7 5/16" x 5/16"
- #8 13/32" x 13/32"
- #10 7/16" x 7/16"

Metal Channel Material

(Galvanized is most common)

- Galvanized Stainless Steel
- Aluminum (Straight Strip #4 and #7)

Configuration

- Straight Strip
Inside Diameter _____
Outside Diameter _____
- Inward Wound Disk
Inside Diameter _____
Outside Diameter _____
- Outward Wound Disk
Inside Diameter _____
Outside Diameter _____
- Inward Wound Spiral
Inside Diameter _____
Outside Diameter _____
Pitch _____
- Outward Wound Spiral
Inside Diameter _____
Outside Diameter _____
Pitch _____
- Cup _____
Inside Diameter _____
Outside Diameter _____

Wet or Dry Use? _____

Ends Deburred: Yes No

Order Quantity _____

Annual Usage _____

Strip Brush Nomenclature

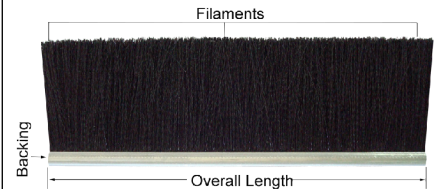
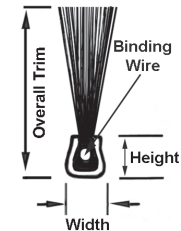

CUSTOMER CONTACT INFORMATION

Name _____

Company _____

Phone _____

Email _____

Micro Single Spiral Brushes

Miniature single spiral brushes with a stainless steel stem and a ring handle.

Brush Dia.	Brush Length	Stem Dia.	Bristle Dia.	Overall Length	Stainless Steel Part #	Brass Part #	Nylon Part #
.020"	1/4"	.014"	.003"	3"	01001	01002	01003
.030"	1/4"	.015"	.003"	3"	01021	01022	01023
.040"	1/2"	.025"	.003"	4"	01031	01032	01033
.050"	1/2"	.035"	.003"	4"	01051	01052	01053
.060"	1/2"	.035"	.003"	4"	01071	01072	01073
.070"	3/4"	.035"	.003"	4"	01091	01092	01093
.080"	3/4"	.044"	.003"	4"	01101	01102	01103
.090"	1"	.044"	.003"	4"	01111	01112	01113
.100"	1"	.044"	.003"	4"	01131	01132	01133
.110"	1"	.044"	.003"	4"	01141	01142	01143
.125"	1"	.044"	.003"	4"	01151	01152	01153
.130"	1"	.044"	.003"	4"	01161	01162	01163
.140"	1"	.070"	.003"	4"	01171	01172	01173
.150"	1"	.070"	.003"	4"	01181	01182	01183
.160"	1"	.070"	.003"	4"	01201	01202	01203
.170"	1"	.070"	.003"	4"	01211	01212	01213
.180"	1"	.070"	.003"	4"	01221	01222	01223
.190"	1"	.070"	.003"	4"	01231	01232	01233



Abrasive Nylon Micro Single Spiral Brushes

Designed for ultra-fine deburring, edge blending and cleaning.

Brush Dia.	For Hole Diameters: Decimal Fraction	Brush Length	Stem Dia.	Overall Length	Abrasive Part #	
Made with .008 Silicate Nylon and Stainless Steel Stem Wire:						
.035"	.032"	1/32"	5/8"	.016"	3"	01301
.052"	.047"	3/64"	3/4"	.026"	3"	01309
Made with 600 Grit Aluminum Oxide Nylon and Stainless Steel Stem Wire:						
.069"	.063"	1/16"	3/4"	.026"	3"	01321
.087"	.079"	5/64"	3/4"	.034"	3"	01325
.103"	.094"	3/32"	3/4"	.043"	3"	01329
.120"	.109"	7/64"	3/4"	.055"	3"	01333
.138"	.125"	1/8"	1"	.055"	3"	01337
.172"	.156"	5/32"	1"	.072"	3"	01441
.208"	.189"	3/16"	1"	.072"	3"	01445



Abrasive Nylon Single Spiral Brushes

Made with 500 Grit Aluminum Oxide Nylon and Stainless Steel Stem Wire:

.275"	.250"	1/4"	1-1/2"	.110"	3"	01449
.344"	.313"	5/16"	1-1/2"	.125"	3"	01453
.413"	.375"	3/8"	1-1/2"	.160"	3"	01457
.550"	.500"	1/2"	1-1/2"	.160"	3"	01461

Made with 600 Grit Aluminum Oxide Nylon and Galvanized Stem Wire:

.640"	.625"	5/8"	1"	.165"	5"	01465
.765"	.750"	3/4"	1"	.225"	5"	01469
.890"	.875"	7/8"	1"	.225"	5"	01473
1.015"	1.000"	1"	1"	.225"	5"	01477



Thread Cleaning Brushes

Stainless steel base wire. Sizes 0-8 have a ring. All other sizes have a cut end.

Thread Size	Brush Length	Overall Length	Stem Dia.	Brush Dia.	Stainless Steel Part #	Brass Part #	Nylon Brush Dia.	Nylon Part #
#0	3/4"	4"	.035"	.060"	TCS-0	TCB-0	.080"	TCN-0
#2	3/4"	4"	.035"	.086"	TCS-2	TCB-2	.098"	TCN-2
#4	1"	4"	.050"	.113"	TCS-4	TCB-4	.125"	TCN-4
#6	1"	4"	.058"	.140"	TCS-6	TCB-6	.150"	TCN-6
#8	1"	4"	.058"	.166"	TCS-8	TCB-8	.166"	TCN-8
#10	1"	4"	.070"	.191"	TCS-10	TCB-10	.191"	TCN-10
1/4"	1"	4-1/2"	.090"	1/4"	TCS-1/4	TCB-1/4	1/4"	TCN-1/4
5/16"	1"	4-1/2"	.090"	5/16"	TCS-5/16	TCB-5/16	5/16"	TCN-5/16
3/8"	1"	4-1/2"	.110"	3/8"	TCS-3/8	TCB-3/8	3/8"	TCN-3/8
7/16"	1-1/2"	4-1/2"	.110"	7/16"	TCS-7/16	TCB-7/16	7/16"	TCN-7/16
1/2"	1-1/2"	4-1/2"	.110"	1/2"	TCS-1/2	TCB-1/2	1/2"	TCN-1/2
3/4"	1-1/2"	4-1/2"	.145"	3/4"	TCS-3/4	TCB-3/4	3/4"	TCN-3/4

SPIRAL BRUSH CONSTRUCTION

Single Spiral, Single Stem

One layer of filament twisted between two single stem wires.



Single Spiral, Double Stem

One layer of filament twisted between double stem wires, for added strength.



Double Spiral, Double Stem

Two layers of filament twisted between four stem wires, with each layer perpendicular to the other. This is the strongest spiral brush with the highest density of filament.



Single Spiral Brushes with Ring Handle

Single spiral, single stem wire fill with a ring handle, for manual cleaning. Galvanized stem wire on all except "stainless steel fill/stem."

Brush Dia.	Brush Length	Overall Length	Stem Dia.	Wire Dia.	Carbon Steel Part #	Stainless Steel Part #	Stainless Steel Fill/Stem Part #	Brass Part #
1/8"	1"	6"	.090"	.003"	95000	97002	98002*	91002
1/8"	1"	6"	.090"	.005"	95005	97004	98005*	91004
3/16"	1-1/2"	7"	.090"	.003"	95006	97005	98006*	91006
3/16"	1-1/2"	7"	.090"	.005"	95008	97008	98008*	91008
1/4"	1-1/2"	7"	.090"	.003"	95010	97010	98010*	91010
1/4"	1-1/2"	7"	.090"	.005"	95012	97015	98012*	91012
1/4"	3"	27"	.090"	.005"	95014	97016	98014*	91014
5/16"	1-1/2"	7"	.090"	.004"	95016	97017	98016*	91016
5/16"	1-1/2"	7"	.090"	.006"	95018	97018	98018*	91018
3/8"	2"	8"	.110"	.004"	95020	97020	98020	91020
3/8"	2"	8"	.110"	.006"	95022	97022	98022	91022
3/8"	3"	27"	.145"	.005"	95024	97024	98024	91024
7/16"	2"	8"	.110"	.004"	95026	97026	98026	91026
7/16"	2"	8"	.110"	.006"	95028	97028	98028	91028
1/2"	2"	8"	.110"	.004"	95029	97030	98030	91030
1/2"	2"	8"	.110"	.006"	95032	97032	98032	91032
1/2"	3"	27"	.165"	.006"	95034	97034	98034	91034
9/16"	2-1/2"	9"	.145"	.005"	95036	97036	98036	91036
9/16"	2-1/2"	9"	.145"	.008"	95038	97038	98038	91038
5/8"	2-1/2"	9"	.145"	.005"	95040	97040	98040	91040
5/8"	2-1/2"	9"	.145"	.008"	95042	97042	98042	91042
5/8"	3"	27"	.190"	.006"	95044	97044	98044	91044
11/16"	2-1/2"	9"	.145"	.005"	95046	97046	98046	91046
11/16"	2-1/2"	9"	.145"	.008"	95048	97048	98048	91048
3/4"	2-1/2"	9"	.145"	.005"	95050	97050	98050	91050
3/4"	2-1/2"	9"	.145"	.008"	95052	97052	98052	91052
3/4"	3"	27"	.190"	.006"	95054	97054	98054	91054
13/16"	3"	10"	.165"	.005"	95056	97056	98056	91056
13/16"	3"	10"	.165"	.008"	95058	97058	98058	91058
7/8"	3"	10"	.165"	.005"	95060	97060	98060	91060
7/8"	3"	10"	.165"	.008"	95062	97062	98062	91062
7/8"	3"	27"	.190"	.006"	95064	97064	98064	91064
1"	3"	10"	.165"	.005"	95066	97066	98066	91066
1"	3"	10"	.165"	.008"	95068	97068	98068	91068
1"	3"	27"	.190"	.006"	95070	97070	98070	91070
1-1/4"	3"	27"	.190"	.006"	95072	97072	98072	91072
1-1/2"	3"	27"	.190"	.008"	95074	97074	98074	91074

*.070" Stem diameter

Single Spiral, Single Stem Nylon or Horse Hair with Ring Handle and Galvanized Stem

Brush Dia.	Brush Length	Overall Length	Stem Dia.	Nylon Dia.	Nylon Part #	Horse Hair Part #
1/4"	2"	6-1/4"	.070"	.006"	432100	499101
1/4"	4"	26"	.110"	.006"	432101	499099
5/16"	1-1/2"	9"	.110"	.006"	432114	499112
3/8"	2"	6-1/4"	.070"	.006"	431125	499123
3/8"	4"	26"	.135"	.006"	432126	499124
1/2"	1-1/2"	7-1/2"	.070"	.012"	435151	499148
1/2"	3"	8-1/2"	.070"	.012"	435149	499149
1/2"	4"	26"	.110"	.012"	435148	499152
1/2"	4-1/2"	42"	.145"	.012"	435152	499153
5/8"	3"	8-1/2"	.145"	.012"	435173	499173
5/8"	4-1/2"	42"	.145"	.012"	435175	499175
3/4"	3"	8-1/2"	.145"	.012"	435200	499201
3/4"	4-1/2"	42"	.145"	.014"	436200	499199
1"	4"	12-1/4"	.145"	.012"	435225	499224
1"	4-1/2"	40-1/2"	.225"	.014"	436225	499225
1-1/4"	4"	13"	.165"	.014"	436237	499237
1-1/4"	4-1/2"	40-1/2"	.225"	.014"	436239	499238
1-1/4"	5"	12"	.145"	.014"	436238**	499198**
1-1/2"	4-1/2"	40-1/2"	.225"	.014"	436250	499249
2"	4-1/2"	40-1/2"	.225"	.014"	436265	499265

**Brush diameter tapers from 1-1/4" to 3/4"



Single Spiral Power Brushes

Single spiral, single stem with galvanized wire for use in portable tools and drill presses.

Brush Dia.	Brush Length	Overall Length	Stem Dia.	Wire Dia.	Carbon Steel Part #	Stainless Steel Part #	Brass Part #
1/4"	1"	3-1/2"	.110"	.004"	30005	30007	30001
5/16"	1"	3-1/2"	.110"	.004"	30015	30017	30011
3/8"	1"	3-1/2"	.110"	.004"	30025	30027	30021
3/8"	1"	3-1/2"	.145"	.008"	30035	30037	30031
7/16"	1"	3-1/2"	.145"	.005"	30045	30047	30041
1/2"	1"	3-1/2"	.165"	.005"	30055	30057	30051
9/16"	1"	3-1/2"	.190"	.005"	30065	30067	30061
5/8"	1"	3-1/2"	.165"	.005"	30075	30077	30071
5/8"	1"	3-1/2"	.190"	.008"	30085	30087	30081
11/16"	1"	3-1/2"	.190"	.005"	30095	30097	30091
3/4"	1"	3-1/2"	.225"	.006"	30105	30107	30101
13/16"	1"	3-1/2"	.225"	.006"	30115	30117	30111
7/8"	1"	3-1/2"	.225"	.006"	30125	30127	30121
15/16"	1"	3-1/2"	.225"	.006"	30135	30137	30131
1"	1"	3-1/2"	.225"	.005"	30145	30147	30141
1"	1"	3-1/2"	.225"	.008"	30155	30157	30151
1-1/8"	1"	3-1/2"	.225"	.005"	30165	30167	30161
1-1/8"	1"	3-1/2"	.225"	.008"	30175	30177	30171
1-1/4"	1"	3-1/2"	.225"	.008"	30185	30187	30181
1-1/2"	1"	3-1/2"	.225"	.008"	30195	30197	30191

Single Spiral, Single Stem



One layer of filament twisted between two single stem wires.

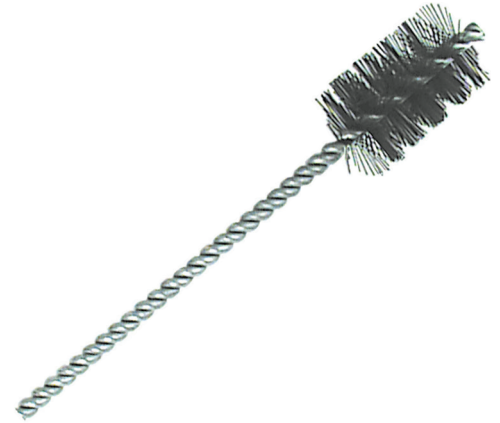

Abrasive Single Spiral Power Brushes

Single spiral, double stem, galvanized wire filled with silicon carbide abrasive nylon for a high degree of stiffness and a fast-cutting rate. For wet or dry applications. Can be used manually or in power tools.

Brush Dia.	Brush Length	Overall Length	Stem Dia.	Nylon Dia.	Grit Size	Part #
1/4"	1-1/2"	4"	.120"	.022"	320	40003
3/8"	1-1/2"	4"	.120"	.022"	320	40006
1/2"	2"	5"	.162"	.022"	320	40009
1/2"	2"	5"	.162"	.040"	80	40012
5/8"	2"	5"	.207"	.022"	320	40015
5/8"	2"	5"	.207"	.040"	80	40018
11/16"	2"	5"	.207"	.022"	320	40021
3/4"	2-1/2"	5-1/2"	.243"	.022"	320	40024
3/4"	2-1/2"	5-1/2"	.243"	.040"	80	40027
7/8"	2-1/2"	5-1/2"	.243"	.022"	320	40030
1"	2-1/2"	5-1/2"	.243"	.022"	320	40033
1-1/8"	2-1/2"	5-1/2"	.243"	.012"	600*	40036
1-1/8"	2-1/2"	5-1/2"	.243"	.022"	320	40039
1-1/8"	2-1/2"	5-1/2"	.243"	.022"	120	40042
1-1/4"	2-1/2"	5-1/2"	.243"	.022"	320	40045
1-1/4"	2-1/2"	5-1/2"	.243"	.022"	120	40048
1-1/2"	2-1/2"	5-1/2"	.243"	.012"	600*	40051
1-1/2"	2-1/2"	5-1/2"	.243"	.022"	320	40054
1-1/2"	2-1/2"	5-1/2"	.243"	.040"	80	40057
1-3/4"	2-1/2"	5-1/2"	.243"	.040"	80	40060
2"	2-1/2"	5-1/2"	.243"	.012"	600*	40063
2"	2-1/2"	5-1/2"	.243"	.022"	320	40066
2"	2-1/2"	5-1/2"	.243"	.040"	80	40069

*Aluminum Oxide Abrasive Nylon

Single Spiral, Double Stem



One layer of filament twisted between double stem wires, for added strength.



IMPORTANT

Always operate a spiral brush in the same direction the stem is twisted. Rotating in the opposite direction may loosen the stem wire and cause the brush to fall apart.

POWER BRUSH OPERATING RECOMMENDATIONS

- Spiral Power Brushes are manufactured for a standard drill with a clockwise rotation. Using a counter-clockwise rotation may cause the brush to fall apart.
- Avoid any load conditions and brush speeds that could cause the stem to bend or the brush to break.
- Guide the brush into the hole before starting the brush rotation.
- To reach into deeper holes, use drill extension rods instead of using a brush with a long stem length.

Double Spiral, Double Stem



Two layers of filament twisted between four stem wires, with each layer perpendicular to the other. This is the strongest spiral brush with the highest density of filament.



Double Spiral Power Brushes

Heavy duty double spiral, double stem construction for added strength. Brushes come with galvanized steel stem unless otherwise mentioned.

Brush Dia.	Brush Length	Overall Length	Stem Dia.	Fill Dia.	Carbon Steel Part #	Stainless Steel		Nylon Part #	
						Steel Part #	Fill/Stem Part #		
1/4"	1-1/2"	4"	.120"	.003"	50005	50007	50008	50001	50003
1/4"	1-1/2"	4"	.120"	.005"	50015	50017	50018	50011	50013
5/16"	1-1/2"	4"	.120"	.003"	50025	50027	50028	50021	50023
5/16"	1-1/2"	4"	.120"	.005"	50035	50037	50038	50031	50033
3/8"	1-1/2"	4"	.120"	.003"	50045	50047	50048	50041	50043
3/8"	1-1/2"	4"	.120"	.005"	50055	50057	50058	50051	50053
7/16"	2"	5"	.158"	.004"	50065	50067	50068	50061	50063
7/16"	2"	5"	.158"	.006"	50075	50077	50078	50071	50073
1/2"	2"	5"	.158"	.004"	50085	50087	50088	50081	50083
1/2"	2"	5"	.158"	.006"	50095	50097	50098	50091	50093
9/16"	2"	5"	.205"	.005"	50105	50107	50108	50101	50103
9/16"	2"	5"	.205"	.008"	50115	50117	50118	50111	50113
5/8"	2"	5"	.205"	.005"	50125	50127	50128	50121	50123
5/8"	2"	5"	.205"	.008"	50135	50137	50138	50131	50133
11/16"	2"	5"	.235"	.005"	50145	50147	50148	50141	50143
11/16"	2"	5"	.235"	.008"	50155	50157	50158	50151	50153
3/4"	2-1/2"	5-1/2"	.235"	.006"	50165	50167	50168	50161	50163
3/4"	2-1/2"	5-1/2"	.235"	.010"	50175	50177	50178	50171	50173
13/16"	2-1/2"	5-1/2"	.235"	.006"	50185	50187	50188	50181	50183
13/16"	2-1/2"	5-1/2"	.235"	.010"	50195	50197	50198	50191	50193
7/8"	2-1/2"	5-1/2"	.235"	.006"	50205	50207	50208	50201	50203
7/8"	2-1/2"	5-1/2"	.235"	.010"	50215	50217	50218	50211	50213
15/16"	2-1/2"	5-1/2"	.235"	.006"	50225	50227	50228	50221	50223
15/16"	2-1/2"	5-1/2"	.235"	.010"	50235	50237	50238	50231	50233
1"	2-1/2"	5-1/2"	.235"	.006"	50245	50247	50248	50241	50243
1"	2-1/2"	5-1/2"	.235"	.010"	50255	50257	50258	50251	50253
1-1/16"	2-1/2"	5-1/2"	.235"	.010"	50265	50267	50268	50261	50263
1-1/8"	2-1/2"	5-1/2"	.235"	.006"	50275	50277	50278	50271	50273
1-1/8"	2-1/2"	5-1/2"	.235"	.010"	50285	50287	50288	50281	50283
1-1/4"	2-1/2"	5-1/2"	.235"	.006"	50295	50297	50298	50291	50293
1-1/4"	2-1/2"	5-1/2"	.235"	.010"	50305	50307	50308	50301	50303
1-3/8"	2-1/2"	5-1/2"	.235"	.006"	50315	50317	50318	50311	50313
1-3/8"	2-1/2"	5-1/2"	.235"	.010"	50325	50327	50328	50321	50323
1-1/2"	2-1/2"	5-1/2"	.235"	.006"	50335	50337	50338	50331	50333
1-1/2"	2-1/2"	5-1/2"	.235"	.010"	50345	50347	50348	50341	50343
1-3/4"	2-1/2"	5-1/2"	.235"	.010"	50355	50357	50358	50351	50353
1-3/4"	2-1/2"	5-1/2"	.235"	.012"	50365	50367	50368	50361	50363
2"	2-1/2"	5-1/2"	.235"	.012"	50375	50377	50378	50371	50373

POWER BRUSH SAFETY

Power brush operators must comply with the Safety Standards of the Industrial Division of the American Brush Manufacturers Association and the American National Standards Institute ANSI B165.1 - 2000 Power-Driven Brushing Tools - Safety Requirements for Design, Care and Use. Appropriate clothing and equipment, including safety goggles or full face shields, must be used where there is a possibility of injury that can be prevented by such clothing and equipment. These requirements are not necessarily complete with respect to any particular application and common sense safety considerations should prevail. Any applicable federal, state or local law regulation must be strictly adhered to and is controlling over any recommendation contained herein.

Condenser Tube Brushes

Single Spiral, Double Stem with a Threaded Shank (Nipple)

Galvanized steel stem. Overall length is 2-3 inches longer than brush length.

Brush Dia.	Brush Length	Female Thread	Male Thread	Stainless Dia.	Part #	Brass Dia.	Part #	Nylon‡ Dia.	Part #
1/4"	3"	8-32	8-32	.005"	47003+	.004"	41003+	.014"	43003+
3/8"	4"	12-24	8-32	.005"	47006+	.004"	41006+	.016"	43006+
7/16"	4"	12-24	1/4"-28	.005"	47009+	.005"	41009+	.016"	43009+
1/2"	4"	12-24	1/4"-28	.006"	47012+	.005"	41012+	.018"	43012+
9/16"	4"	12-24	1/4"-28	.006"	47015+	.005"	41015+	.018"	43015+
5/8"	4"	12-24	1/4"-28	.006"	47018+	.005"	41018+	.018"	43018+
11/16"	4"	12-24	1/4"-28	.006"	47021+	.006"	41021+	.020"	43021+
3/4"	4"	12-24	1/4"-28	.006"	47024+	.006"	41024+	.020"	43024+
13/16"	4"	12-24	1/4"-28	.007"	47027+	.006"	41027+	.020"	43027+
7/8"	4"	12-24	1/4"-28	.007"	47030+	.008"	41030+	.022"	43030+
15/16"	4"	12-24	1/4"-28	.009"	47033+	.008"	41033+	.022"	43033+
1"	4"	12-24	1/4"-28	.009"	47036+	.008"	41036+	.022"	43036+
1-1/4"	4-1/2"		1/4" NPT	.009"	47039	.006"	41039	.018"	43039*
1-1/2"	4-1/2"		1/4" NPT	.009"	47042	.006"	41042	.020"	43042*
1-3/4"	4-1/2"		1/4" NPT	.009"	47045	.006"	41045	.020"	43045*
2"	4-1/2"		1/4" NPT	.009"	47048	.008"	41048	.022"	43048*
2-1/4"	4-1/2"		1/4" NPT	.009"	47051	.008"	41051	.025"	43051*
2-1/2"	4-1/2"		1/4" NPT	.009"	47054	.008"	41054	.025"	43054*
2-3/4"	4-1/2"		1/4" NPT	.013"	47057	.008"	41057	.028"	43057*
3"	4-1/2"		1/4" NPT	.013"	47060	.008"	41060	.036"	43060*
3-1/2"	4-1/2"		1/4" NPT	.013"	47063	.012"	41063	.036"	43063*
4"	4-1/2"		1/4" NPT	.016"	47066	.012"	41066	.036"	43066*

‡Nylon Brushes are Single Stem

*5" Brush Length

+Order with F for Female

Double Spiral, Double Stem with a Threaded Shank (Nipple)

Built to handle the toughest jobs. Heavy galvanized steel stems with very dense wire fill. Overall length is 7-3/4" - 8".

Brush Dia.	Brush Length	Female Thread	Male Thread	Carbon Steel Dia.	Part #	Stainless Steel Dia.	Part #
1/2"	4-1/2"	12-24				.006"	67003
3/4"	4-1/2"	12-24				.006"	67007
1"	4-1/2"	12-24				.009"	67009
1"	4-1/2"		1/4" NPT	.012"	65009		
1-1/4"	4-1/2"		1/4" NPT	.013"	65012	.007"	67012
1-1/2"	4-1/2"		1/4" NPT	.013"	65015	.007"	67015
1-3/4"	4-1/2"		1/4" NPT	.013"	65018	.007"	67018
2"	4-1/2"		1/4" NPT	.013"	65021	.009"	67021
2-1/4"	4-1/2"		1/4" NPT	.013"	65024	.009"	67024
2-1/2"	4-1/2"		1/4" NPT	.013"	65027	.009"	67027
2-3/4"	4-1/2"		1/4" NPT	.014"	65030	.012"	67030
3"	4-1/2"		1/4" NPT	.014"	65033	.013"	67033
3-1/4"	4-1/2"		1/4" NPT	.014"	65036	.013"	67036
3-1/2"	4-1/2"		1/4" NPT	.018"	65039	.013"	67039
3-3/4"	4-1/2"		1/4" NPT	.018"	65042	.016"	67042

Duct and Flue Brushes

Heavy-duty galvanized large diameter brushes filled with tempered steel or durable polypropylene.

Brush Dia.	Brush Length	Overall Length	Male Thread	Double Spiral, Double Stem Tempered Steel Dia.	Part #	Single Spiral, Double Stem Polypropylene Dia.	Part #
5"	4.5"	7"	1/4" NPT	.018"	85003	.060"	84003
6"	4.5"	7"	1/4" NPT	.018"	85006		
6"	6"	9"	1/4" NPT			.075"	84006
7"	4.5"	7"	1/4" NPT	.023"	85009	.075"	84009
8"	6"	9"	1/4" NPT	.023"	85012	.078"	84012
10"	6"	9"	1/4" NPT	.029"	85015	.078"	84015
12"	6"	9"	1/4" NPT	.029"	85018	.078"	84018

Additional sizes can be made.

Single Spiral, Double Stem



One layer of filament twisted between double stem wires, for added strength.



Double Spiral, Double Stem



Two layers of filament twisted between four stem wires, with each layer perpendicular to the other. This is the strongest spiral brush with the highest density of filament.

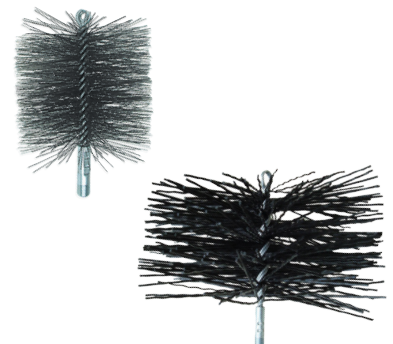

Side Action Brushes—Paddle Brushes

Stainless steel single stem with side tufts for power tool use. Provides a high degree of bristle stiffness with minimal flexing. Use for cleaning and polishing inner walls of tubes, cylinders and blind-threaded holes. Can also be used with brush holders listed below.



Brush Dia.	Brush Length	Overall Length	Stem Dia.	Wire Dia.	Carbon Steel Part #	Stainless Part #
1/4"	9/16"	2-1/8"	.070"	.003"	25003	27003
1/4"	9/16"	2-1/8"	.070"	.005"	25006	27006
5/16"	9/16"	2-1/8"	.070"	.003"	25009	27009
5/16"	9/16"	2-1/8"	.070"	.005"	25012	27012
3/8"	9/16"	2-1/8"	.070"	.003"	25015	27015
3/8"	9/16"	2-1/8"	.070"	.005"	25018	27018
3/8"	9/16"	2-1/8"	.070"	.008"	25021	27021
7/16"	9/16"	2-1/8"	.070"	.003"	25024	27024
7/16"	9/16"	2-1/8"	.070"	.005"	25027	27027
7/16"	9/16"	2-1/8"	.070"	.008"	25030	27030
1/2"	9/16"	2-1/8"	.070"	.003"	25033	27033
1/2"	9/16"	2-1/8"	.070"	.005"	25036	27036
1/2"	9/16"	2-1/8"	.070"	.008"	25039	27039
9/16"	5/8"	2-1/4"	.135"	.003"	25042	27042
9/16"	5/8"	2-1/4"	.135"	.005"	25045	27045
9/16"	5/8"	2-1/4"	.135"	.008"	25048	27048
5/8"	5/8"	2-1/4"	.135"	.003"	25051	27051
5/8"	5/8"	2-1/4"	.135"	.005"	25054	27054
5/8"	5/8"	2-1/4"	.135"	.008"	25057	27057
3/4"	5/8"	2-1/4"	.135"	.003"	25060	27060
3/4"	5/8"	2-1/4"	.135"	.005"	25063	27063
3/4"	5/8"	2-1/4"	.135"	.008"	25066	27066
7/8"	5/8"	2-1/4"	.135"	.003"	25069	27069
7/8"	5/8"	2-1/4"	.135"	.005"	25072	27072
7/8"	5/8"	2-1/4"	.135"	.008"	25075	27075
1"	5/8"	2-1/4"	.135"	.003"	25078	27078
1"	5/8"	2-1/4"	.135"	.005"	25081	27081
1"	5/8"	2-1/4"	.135"	.008"	25084	27084
1-1/8"	5/8"	2-1/4"	.135"	.003"	25087	27087
1-1/8"	5/8"	2-1/4"	.135"	.005"	25090	27090
1-1/8"	5/8"	2-1/4"	.135"	.008"	25093	27093
1-1/4"	5/8"	2-1/4"	.135"	.003"	25096	27096
1-1/4"	5/8"	2-1/4"	.135"	.005"	25098	27098
1-1/4"	5/8"	2-1/4"	.135"	.008"	25099	27099



Brush Holders for Side Action Brushes

When attached to a side action brush, it slightly reduces bristle trim length for a stiffer, more aggressive brush action that can be driven at a higher RPM.

Brush Stem Dia.	Holder Shank Dia.	Overall Length	Part #
.070"	1/4"	3-1/8"	27001
.135"	3/8"	3-3/8"	27002

Valve Brushes

Twisted-in-wire valve brushes with stainless steel construction. Nylon bristles for long lasting use. Polypropylene handle cap with hang hole for convenient storage.

Brush Head Dia.	Brush Length	Overall Length	Part #
1"	6-1/4"	18-1/4"	449225-3
1-1/2"	6-1/4"	18-1/4"	449250-1
2"	6-1/4"	18-1/4"	449266-4
3"	6-1/4"	18-1/4"	449298-1



Handles and Extension Rods for Threaded Brushes

Part #	Handles	Material
86047	Wire-formed handle for 8-32 extension rod	Steel
86048	T-handle for 12-24 extension rods	Aluminum
86051	T-handle for 1/4"-28 extension rod	Aluminum
86052	T-handle for 1/4" NPT extension rods	Galvanized

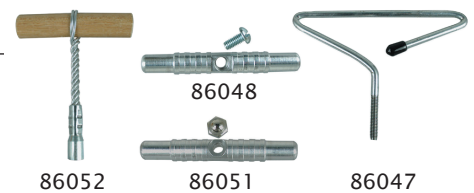

Part #	Thread	Male/ Female	Dia.	Overall Length	Material
Extension Rods					
86018	8-32	M & F	3/16"	24"	Steel
86021	12-24	M & F	5/16"	24"	Aluminum
86027	12-24	M & F	5/16"	36"	Aluminum
86024	1/4"-28	M & F	1/4"	36"	Steel
86030	1/4" NPT	M & F	3/8"	36"	Fiberglass/Steel ends
86036	1/4" NPT	M & F	3/8"	48"	Fiberglass/Steel ends

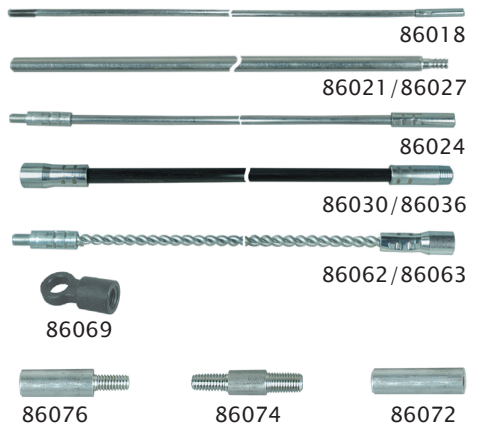

Semi-Flexible Twisted Steel Extension Rods					
86062	1/4" NPT	M & F	3/8"	60"	Steel
86063	1/4" NPT	M & F	3/8"	72"	Steel

Pull Ring For 1/4" NPT Brushes					
86069	1/4" NPT	Female	1/2" Dia.	Pull Ring	Steel

Adaptors For Threaded Brushes					
86072	8-32	Female to 8-32 Female			Aluminum
86074	1/4"-28	Male to 12-24 Male			Aluminum
86076	1/4"-28	Female to 12-24 Male			Aluminum

Radiator Brushes

Long spiral brushes with wood handle and galvanized stem wire for cleaning coils, springs, registers, radiators and anywhere that requires an extended reach.

Part #	Fill Material	Brush Dia.	Brush Length	Overall Length	Handle Length
446266-1	.014 Crimped Nylon	2"	5"	30-1/2"	4"
499266-4	Horse hair	2"	5"	30-1/2"	4"



Spoke Brush

Pointed end spoke brush for any hard-to-reach auto detailing. Twisted-in-wire brush with tampico bristles.

Part #	Fill Material	Material Handle	Brush Dia.	Brush Length	Overall Length	Handle Length
M578340	Tampico	Hardwood	3"	11"	16"	5"
M578350	Tampico Colored Poly	Plastic	2"	6"	11"	5"



Refrigeration and Plumbing Brushes

Tube-fitting brushes are double spiral, double stem with stainless steel wire, galvanized steel stems and a plastic grip.

Stainless Part #	Refrigeration OD	Plumbing ID	Brush Dia.	Brush Length	Overall Length	Wire Dia.
84103	1/4"	1/8"	9/32"	1-1/4"	6-5/8"	.005"
84106	3/8"	1/4"	7/16"	1-1/4"	6-5/8"	.006"
84109	1/2"	3/8"	9/16"	1-1/4"	6-5/8"	.006"
84112	5/8"	1/2"	11/16"	1-1/4"	6-5/8"	.006"
84115	3/4"	5/8"	13/16"	1-1/4"	6-5/8"	.006"
84118	7/8"	3/4"	15/16"	1-1/4"	6-5/8"	.006"
84121	1-1/8"	1"	1-3/16"	1-1/4"	6-5/8"	.008"
84224	1-3/8"	1-1/4"	1-7/16"	1-1/4"	6-5/8"	.008"
84227	1-5/8"	1-1/2"	1-3/4"	1-1/4"	6-5/8"	.009"
84229	2-1/8"	2"	2-1/4"	1-1/4"	6-5/8"	.009"



4-in-1 Double-Ended Tube/Fitting Brushes

High carbon steel single spiral, single stem with a plastic handle.

Part #	Tube/Fitting Size (OD)	Brush Dia.	Brush Length	Overall Length	Wire Dia.
84303	1/2", 3/4"	9/16", 13/16"	1"	7-1/2"	.006"
84306	7/8", 11/16"	11/16", 15/16"	1"	7-1/2"	.006"



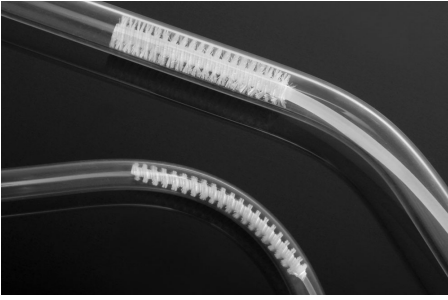

Metal Free Tube Brushes

Metal free tube brushes are made with 100% food grade polypropylene, handle and bristles. Polypropylene is resistant to acids, alkalis, alcohols, and many petroleum distillates. These brushes can be used to clean the inside of straight or curved tubes, pipes, valves, and fittings. They are great when moderate to aggressive scrubbing is needed. These brushes will not scratch most surfaces. Fused bristles help minimize the growth of bacteria. Available in white only.

Flexible Series

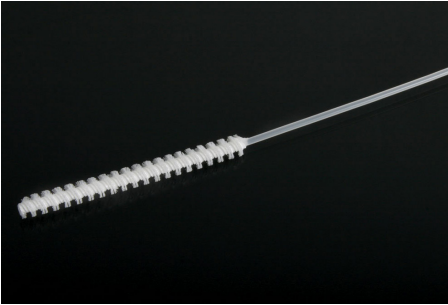

12" overall length		18" overall length		24" overall length		Filament Dia.	Handle Dia.	Brush Length
Part #	Brush Dia.	Part #	Brush Dia.	Part #	Brush Dia.			
710212	1/4"	710218	1/4"	710224	1/4"	.006"	1/8"	4"
710312	3/8"	710318	3/8"	710324	3/8"	.010"	1/8"	4"
710512	1/2"	710518	1/2"	710524	1/2"	.010"	1/4"	4"
710612	5/8"	710618	5/8"	710624	5/8"	.010"	1/4"	4"
710712	3/4"	710718	3/4"	710724	3/4"	.010"	1/4"	4"
710812	7/8"	710818	7/8"	710824	7/8"	.010"	1/4"	4"
711012	1"	711018	1"	711024	1"	.010"	1/4"	4"
711212	1-1/4"	711218	1-1/4"	711224	1-1/4"	.010"	1/4"	4"

Standard Series



12" overall length		18" overall length		24" overall length		Filament Dia.	Handle Dia.	Brush Length
Part #	Brush Dia.	Part #	Brush Dia.	Part #	Brush Dia.			
720712	3/4"	720718	3/4"	720724	3/4"	.010"	3/8"	4"
720812	7/8"	720818	7/8"	720824	7/8"	.010"	3/8"	4"
721012	1"	721018	1"	721024	1"	.010"	3/8"	4"
721212	1-1/4"	721218	1-1/4"	721224	1-1/4"	.010"	3/8"	4"
721512	1-1/2"	721518	1-1/2"	721524	1-1/2"	.010"	3/8"	4"
721812	1-3/4"	721818	1-3/4"	721824	1-3/4"	.010"	3/8"	4"
722012	2"	722018	2"	722024	2"	.016"	3/8"	4"
722512	2-1/2"	722518	2-1/2"	722524	2-1/2"	.016"	3/8"	4"

Rigid Series



12" overall length		18" overall length		24" overall length		Filament Dia.	Handle Dia.	Brush Length
Part #	Brush Dia.	Part #	Brush Dia.	Part #	Brush Dia.			
730712	3/4"	730718	3/4"	730724	3/4"	.010"	1/2"	4"
731012	1"	731018	1"	731024	1"	.010"	1/2"	4"
731212	1-1/4"	731218	1-1/4"	731224	1-1/4"	.010"	1/2"	4"
731512	1-1/2"	731518	1-1/2"	731524	1-1/2"	.010"	1/2"	4"
731712	1-3/4"	731718	1-3/4"	731724	1-3/4"	.010"	1/2"	4"
732012	2"	732018	2"	732024	2"	.016"	1/2"	4"
732512	2-1/2"	732518	2-1/2"	732524	2-1/2"	.016"	1/2"	4"
733012	3"	733018	3"	733024	3"	.016"	1/2"	4"

Double Leader Series

The Double Leader is a push/pull through brush. It has an 8" brush face with a leader and ball on each end.

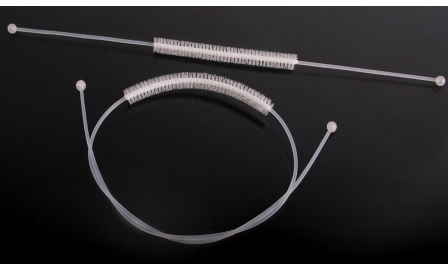

24" overall length		36" overall length		48" overall length		Filament Dia.	Handle Dia.	Brush Length
Part #	Brush Dia.	Part #	Brush Dia.	Part #	Brush Dia.			
740524	1/2"	740536	1/2"	740548	1/2"	.016"	3/16"	8"
740724	3/4"	740736	3/4"	740748	3/4"	.016"	3/16"	8"
741024	1"	741036	1"	741048	1"	.016"	3/16"	8"

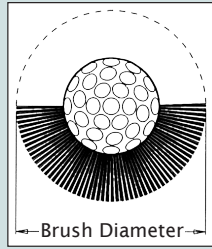
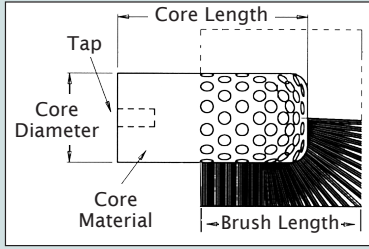

BORE BRUSHES

Bore Brushes are hand or machine-operated, large diameter blind hole brushes that are designed to clean both the wall and the bottom of a hole. They are used when a spiral brush is not strong enough or thick enough to provide sufficient abrasion.

Basic sizes are listed below. Other sizes are available upon request.

Small Nylon Bore Brushes

Core material is HDPE, with a diameter of 1-1/4", and length of 3-5/16". The tap is 1/4-20 UNC or ACME broom thread.

Part #	Fill Material	Thread	Brush Dia.	Brush Length
900565-2.5	.008 Natural crimped 6.12 nylon (FDA compatible)	1/4-20 UNC	2-1/2"	2-7/16"
900565-3.5	.012 Black crimped 6.6 nylon	1/4-20 UNC	3-1/2"	2-11/16"
900565-4	.020 Black crimped 6.6 nylon	1/4-20 UNC	4"	3"
900565-5	.020 Black crimped 6.6 nylon	1/4-20 UNC	5"	3-1/16"
900565-6.5	.028 Black level 6.6 nylon	1/4-20 UNC	6-1/2"	3-7/16"
900565-2.5BT	.008 Natural crimped 6.12 nylon (FDA compatible)	Broom	2-1/2"	2-7/16"
900565-3.5BT	.012 Black crimped 6.6 nylon	Broom	3-1/2"	2-11/16"
900565-4BT	.020 Black crimped 6.6 nylon	Broom	4"	3"
900565-5BT	.020 Black crimped 6.6 nylon	Broom	5"	3-1/16"
900565-6.5BT	.028 Black level 6.6 nylon	Broom	6-1/2"	3-7/16"



Large Nylon Bore Brushes

Core material is PVC (unless noted otherwise*) with a diameter of 3", and a length of 5-1/8". The tap is 1/2-13 UNC or ACME broom thread.

Part #	Fill Material	Thread	Brush Dia.	Brush Length
900674-6	.014 Black crimped 6.6 nylon	1/2-13 UNC	6"	4"
900674-7	.025 Black crimped 6.6 nylon	1/2-13 UNC	7"	4-1/8"
900674-8	.028 Black level 6.6 nylon	1/2-13 UNC	8"	4-1/4"
900674-9	.040 Black level 6.6 nylon	1/2-13 UNC	9"	4-5/16"
900674-6BT	.014 Black crimped 6.6 nylon	Broom	6"	4"
900674-7BT	.025 Black crimped 6.6 nylon	Broom	7"	4-1/8"
900674-8BT	.028 Black level 6.6 nylon	Broom	8"	4-1/4"
900674-9BT	.040 Black level 6.6 nylon	Broom	9"	4-5/16"
900674-10BT*	.032 Natural level 6.12 nylon (FDA compatible)	Broom	10"	5"

*HDPE Core



Stainless Steel Bore Brushes

Core material is PVC with a diameter of 1-1/2" and a length of 5". The tap is 1/2" NPT.

Part #	Fill Material	Brush Diameter	Brush Length
900997-2.5	.006 Stainless steel	2-1/2"	5-1/8"
900997-3.5	.010 Stainless steel	3-1/2"	5-1/2"
900997-4.5	.018 Stainless steel	4-1/2"	5-3/4"
900997-5.5	.020 Stainless steel	5-1/2"	6"
900997-A	1/2" NPT to 1/4" NPT Adapter		



Static Dissipative Bowl Brushes

Static dissipative acetal handle bowl brushes with .010 static dissipative 6.12 nylon filament. Brushes are useful in situations where dust and static electricity are a concern. Brush materials have good chemical resistance.

Part #	Brush Diameter	Brush Length	Overall Length	Handle Dia.
▲901820	3"	6"	16"	1"
▲901820L	3"	6"	26"	1"



Static Dissipative Vat Brush

Typically used in vats where any type of spark could cause an explosion. Static dissipative acetal core has a 1/2" NPT threaded hole. Brush materials have good chemical resistance. .016 static dissipative 6.12 nylon filament.

Part #	Trim	Brush Diameter	Overall Length
▲901724	2"	5-1/2"	9-1/2"
●901724-5	Non-Sparking Aluminum Handle, 1/2" NPT thread for 901724		5'

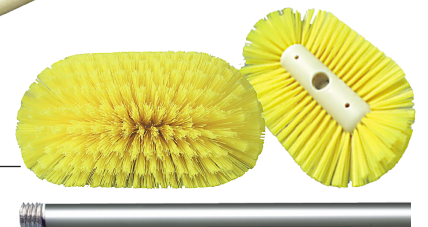

◆ Anti-Static ▲ Static Dissipative ● Conductive

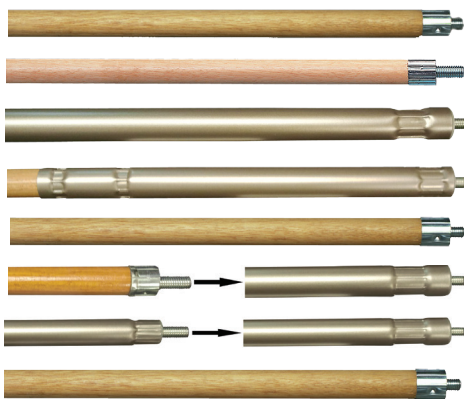

Speed Sweep® 3/8" Stud

Extremely strong, long lasting wood and steel handles with 3/8" stud that will not strip. Handles are used for steel-backed floor brushes, deck scrubs, and floor squeegees.

Part #	Handle (L x D)	Description
M190400	48" x 15/16"	All wood handle for M403151, M403161 (short stud)
M190500	48" x 15/16"	All wood handle for M403130
M190300	60" x 1"	All steel handle
M191000	60" x 15/16"	Wood and steel handle
M190900	60" x 15/16"	All wood handle with steel stud
M191200	60" x 1"	Two piece sectional handle, top wood, bottom steel
M191400	60" x 1"	Two piece all steel handle
M190600	72" x 1-1/8"	All wood handle with steel stud

Fiberglass

Ideal for hygienic applications where the pores of wood handles and the corrosion of steel handles are unacceptable.



Part #	Handle (L x D)	Handle Material	Tip
M197300	36" x 15/16"	Fiberglass handle	ACME thread
M197500	60" x 15/16"	Fiberglass handle	ACME thread
M197511	60" x 15/16"	Fiberglass and steel handle	3/8" stud
M195615	60" x 1"	HySweep™ handle	Compression collar

ACME Threaded

Self-locking handle that is intended for use with ACME threaded brooms or squeegees.



Part #	Handle (L x D)	Handle Material	Tip
M190700	48" x 15/16"	Heavy duty wood handle	Threaded wood tip
R36004	48" x 15/16"	Wood handle	Threaded wood tip
R36014	48" x 15/16"	Wood handle	Threaded metal tip
M194100	60" x 15/16"	Heavy duty wood handle	Heavy duty threaded metal tip
R36005	60" x 15/16"	Wood handle	Threaded wood tip
R36015	60" x 15/16"	Wood handle	Threaded metal tip
R36006	72" x 15/16"	Wood handle	Threaded wood tip
R36016	72" x 15/16"	Wood handle	Threaded metal tip

Tapered

Tapered end allows for easy attachment and removal of compatible brushes and brooms.



Part #	Handle (L x D)	Handle Material	Tip
M191100	60" x 1-1/8"	Wood handle	Tapered

Flow-Thru

Adjustable handle allows liquid to flow through the center of the handle and exit through a cleaning device such as a brush head.



Part #	Handle (L)	Description	Tip
M194800	48"-96"	Padded extension handle	ACME thread

BROOMS

No other broom comes close to matching the unique features of the Speed Sweep system. A steel back is placed over the brush block and crimped permanently onto the block. Steel rivets are then fastened through the entire block to secure the adjustable steel socket. Use handle part #M191000 or other handles with a 3/8" stud.

Fine Duty Polypropylene—For Smooth Surfaces

Sweeps light dust and dirt. Gives extremely long wear. Careful blend of straight and crimped polypropylene creates a superior brush.

Part #	Fill Material	Trim	Overall Length
M233180	Polypropylene	3"	18"
M233240	Polypropylene	3"	24"
M233360	Polypropylene	3"	36"



Gray Flagged Styrene—For Smooth Surfaces

Full body and split tip of each bristle cleans dust and dirt from polished floors to smooth concrete. Ideal for smooth surface sweeping.

Part #	Fill Material	Trim	Overall Length
M236180	Flagged styrene	3"	18"
M236240	Flagged styrene	3"	24"
M236360	Flagged styrene	3"	36"



Medium Duty Polypropylene—For Average Surfaces

Straight polypropylene will not mat or tangle while sweeping a variety of debris. Brush is not harmed by water, chemicals or grease and is extremely long wearing.

Part #	Fill Material	Trim	Overall Length
M231180	Polypropylene	3-1/4"	18"
M231240	Polypropylene	3-1/4"	24"
M231360	Polypropylene	3-1/4"	36"



Stiff Center/Fine Border—For Average Surfaces

Stiff center moves stubborn debris; fine border sweeps dust and dirt.

Part #	Fill Material	Trim	Overall Length
M232180	Polypropylene	3"	18"
M232240	Polypropylene	3"	24"
M232360	Polypropylene	3"	36"



Heavy Duty Polypropylene—For Rough Surfaces

Straight, stiff bristles move heavy debris. Resists abrasion, grease, oils, acids and alkalis.

Part #	Fill Material	Trim	Overall Length
M230180	Polypropylene	4"	18"
M230240	Polypropylene	4"	24"
M230360	Polypropylene	4"	36"



Wire Center/Tampico, Horsehair, Patent Border

Center row of steel wire moves paper, metal and scraps which other brushes miss. Tampico, horsehair and patent border keeps dust from rising into the air. Ideal for difficult sweeping situations.

Part #	Fill Material	Trim	Overall Length
M217240	Wire center, tampico, horsehair, patent	3-1/4"	24"



Heavyweights™ Street Push Brooms

Rugged construction allows brushes to tackle heavy debris. Requires M191100 tapered handle.

Part #	Fill Material	Trim	Color	Overall Length
M338180	Stiff polypropylene	4"	Yellow	18"
M339180	Extra stiff polypropylene	5"	Brown	18"



Static Dissipative Broom

23" wide push broom is made with an oval channel, filled with yellow static dissipative 6.12 nylon. A 5-foot steel handle is available. Recommended for use in static sensitive areas for static-free sweeping.

Part #	Fill Material	Trim
▲ 901735	.015/.022 Static dissipative nylon	3-1/2"
▲ 901735H	5 Foot steel handle	N/A



◆ Anti-Static ▲ Static Dissipative ● Conductive

SEAT SWEEP® FLOOR BROOM

Lightweight impact resistant broom that can easily be moved and maneuvered around seats. Careful blend of straight or curved polypropylene creates a superior brush. Steel screws are then fastened through the entire block to secure the adjustable steel socket.



Straight—Average Duty Polypropylene Bristles

Straight polypropylene will not mat or tangle while sweeping a variety of debris. Brush is not harmed by water or grease and is extremely long wearing. Use handle part #M191000, M190300, M190600, M190900, M191200 or other handles with a 3/8" stud.

Part #	Fill Material	Socket	Trim	Overall Length
M331813	Polypropylene	Flip Flop	3"	18"
M331814	Polypropylene	Standard	3"	18"
M331815	Polypropylene	Flip Flop	2"	18"
M331816	Polypropylene	Standard	2"	18"
M332413	Polypropylene	Flip Flop	3"	24"
M332414	Polypropylene	Standard	3"	24"
M332415	Polypropylene	Flip Flop	2"	24"
M332416	Polypropylene	Standard	2"	24"
M333213	Polypropylene	Flip Flop	3"	32"
M333214	Polypropylene	Standard	3"	32"
M333215	Polypropylene	Flip Flop	2"	32"
M333216	Polypropylene	Standard	2"	32"

Curved—Average Duty Polypropylene Bristles

Curved polypropylene will not mat or tangle while sweeping a variety of debris. Brush is not harmed by water or grease and is extremely long wearing. Use handle part #M191000, M190300, M190600, M190900, M191200 or other handles with a 3/8" stud.



Part #	Fill Material	Socket	Trim	Overall Length
M331823	Polypropylene	Flip Flop	3"	18"
M331824	Polypropylene	Standard	3"	18"
M331825	Polypropylene	Flip Flop	2"	18"
M331826	Polypropylene	Standard	2"	18"
M332423	Polypropylene	Flip Flop	3"	24"
M332424	Polypropylene	Standard	3"	24"
M332425	Polypropylene	Flip Flop	2"	24"
M332426	Polypropylene	Standard	2"	24"
M333223	Polypropylene	Flip Flop	3"	32"
M333224	Polypropylene	Standard	3"	32"
M333225	Polypropylene	Standard	2"	32"
M333226	Polypropylene	Flip Flop	2"	32"



SPEED SWEEP® SPEEDY PAK™

No other brush comes close to matching the unique features of the Speed Sweep® system ... a steel back is placed over the brush block and crimped permanently onto the block. Steel rivets are fastened through the entire block to secure the adjustable steel socket.

Features

- Steel back
- Narrow brush block—strength of the steel back allows for the use of a thinner, narrower brush block
- No large holes drilled in center of block
- Adjustable steel socket and nut
- Steel stud in handle will not strip or break when tightened
- SPEEDY PAK™ brush and handle combination

Benefits

- Block will not crack or split
- Considerable weight savings and easier to use
- Speed Sweep® is strongest in the center of the brush where ordinary brushes are weakest
- A truly ergonomic floor brush adjustable to suit the user
- Handle can be frequently reversed to keep bristles in shape for longest wear
- Brush and handle shipped in single box



Fine Duty—Flagged Styrene Bristles

Full body and split tip of each bristle cleans dust and dirt from polished floors to smooth concrete. A popular brush which has replaced horsehair for most smooth surface sweeping.

Part #	Fill Material	Handle	Trim	Overall Length
M236183	Flagged styrene	Wood/steel sectional	3"	18"
M236243	Flagged styrene	Wood/steel sectional	3"	24"
M236363	Flagged styrene	Wood/steel sectional	3"	36"



Average Duty—Polypropylene Bristles

Straight polypropylene will not mat or tangle while sweeping a variety of debris. Not harmed by water, chemicals or grease, and is extremely long wearing.

Part #	Fill Material	Handle	Trim	Overall Length
M231183	Polypropylene	Wood/steel sectional	3-1/4"	18"
M231243	Polypropylene	Wood/steel sectional	3-1/4"	24"



Stiff Center, Fine Border

Stiff center moves stubborn debris; fine border sweeps dust and dirt. The excellent qualities of polypropylene in an "all purpose" sweeping tool.

Part #	Fill Material	Handle	Trim	Overall Length
M232183	Polypropylene	Wood/steel sectional	3"	18"
M232243	Polypropylene	Wood/steel sectional	3"	24"
M232363	Polypropylene	Wood/steel sectional	3"	36"



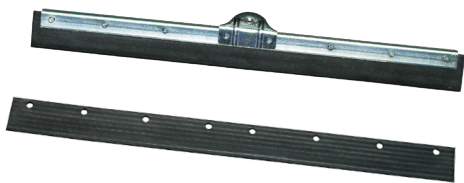

Neoprene in Straight Heavy Duty

Manufactured with heavy gauge zinc-plated steel back. Genuine neoprene blade has excellent wearing qualities. Steel handle accepts any Speed Sweep® bolt-in handle with 3/8" stud, all steel part #M190300 handle recommended.

Part #	Fill Material	Overall Length	Part #	Overall Length
M602510	Neoprene	18"	M602590	18" Refill blade
M602520	Neoprene	24"	M602610	24" Refill blade
M602530	Neoprene	30"	M602620	30" Refill blade
M602540	Neoprene	36"	M602660	36" Refill blade

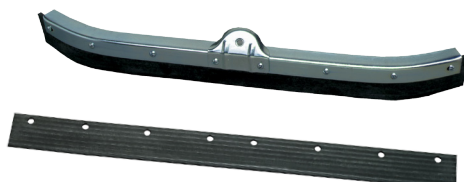

Neoprene in Curved Heavy Duty

Heavy gauge steel back is curved for water retention. Neoprene squeegee blade is chemical and abrasion resistant. Steel socket accepts any Speed Sweep® bolt-in handle with 3/8" stud. All-steel handle part #M190300 recommended.

Part #	Fill Material	Overall Length	Part #	Overall Length
M623240	Neoprene	24"	M602610	24" Refill blade
M623300	Neoprene	30"	M602620	30" Refill blade
M623360	Neoprene	36"	M602660	36" Refill blade



Moss Rubber Double Blade in Steel Housing

Flex Squeegy™ has a soft blade that works well on smooth and textured floors. Double blade with heavy socket dramatically reduces floor drying time. Blades are closed-cell foam material commonly called "moss." Requires handle part #M191000, M190300 or M191200 sectional handle with 3/8" stud.

Part #	Fill Material	Overall Length	Part #	Overall Length
M625182	Moss rubber	18"		
M625242	Moss rubber	24"		
M625300	Moss rubber	30"		
M625360	Moss rubber	36"		

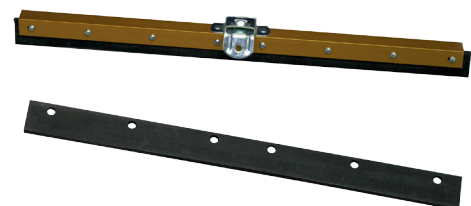

Neoprene Flip Flop® in Aluminum Housing

Socket attachment allows for forward and backward strokes. Blade is split down the middle for double scraping surface and faster drying. Accepts any Speed Sweep® handle with 3/8" stud.

Part #	Fill Material	Overall Length	Part #	Overall Length
M629180	Neoprene	18"	M628180	18" Refill blade
M629240	Neoprene	24"	M628240	24" Refill blade



Moss Rubber Flip Flop® in Aluminum Housing

Combines features of moss rubber with popular Flip Flop® style. Unique socket allows for both backward and forward motion, while the moss rubber blade leaves the surface especially dry. Accepts handle part # M190300, M191000 or M191200 sectional handle with 3/8" stud.

Part #	Fill Material	Overall Length	Part #	Overall Length
M649180	Moss rubber	18"	M925490	18" Refill blade
M649240	Moss rubber	24"	M925491	24" Refill blade



Moss Rubber in Hygienic Housing

Can be used in food processing, food service, laboratories, healthcare, or anywhere hygienic cleaning tools are required. Polypropylene housing holds a moss rubber squeegee blade. Has unique handle socket with a compression lock system for secure attachment. Requires HySweep™ part # M195615 (fiberglass) handle.

Part #	Fill Material	Overall Length	Part #	Overall Length
M645160	Moss rubber	16"		
M645240	Moss rubber	24"		

Speed Squeegy® Speedy Pak™

Speed Squeegy® has a steel socket that accepts any Speed Sweep® bolt-in handle, providing a positive connection that won't come loose. Available in a full range of styles; zinc plated steel and anodized aluminum frames, straight and curved, with stiff neoprene or specialty blades for superior surface contact.

Features

- Straight heavy duty steel with tough neoprene blade
- Curved heavy duty steel
- Flex Squeegy™ steel frame with double moss rubber blade
- Flip Flop® aluminum frame with split neoprene blade
- Straight aluminum frame with pliable, non-marking blade
- Curved aluminum frame

Benefits

- Long wearing under heavy use
- Curved frame improves water retention
- Excellent floor contact for reduced drying time
- Special socket allows forward and backward strokes in obstructed areas
- Light weight alternative with anodized aluminum frame

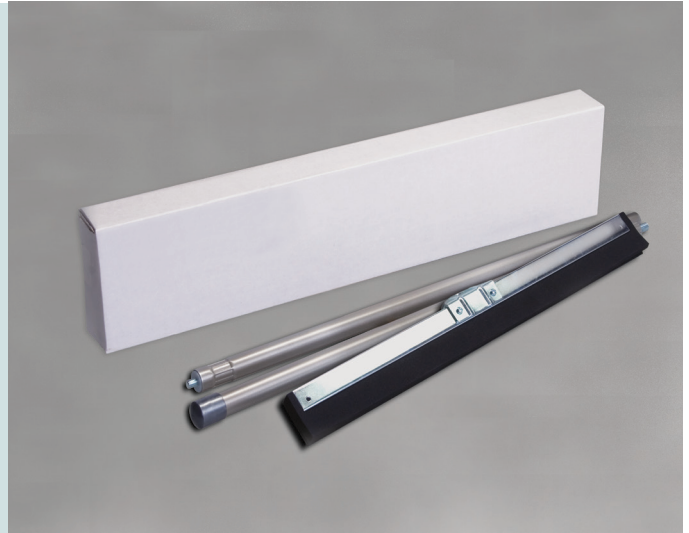

Fine Duty—Moss Rubber Blade

Part #	Blade Material	Frame Type	Handle	Size	Frame Material
M625183	Moss rubber	Straight, heavy duty	Steel/steel sectional	18"	Plated Steel
M625243	Moss rubber	Straight, heavy duty	Wood/steel sectional	24"	Plated Steel
M625303	Moss rubber	Straight, heavy duty	Steel/steel sectional	30"	Plated Steel
M625363	Moss rubber	Straight, heavy duty	Wood/steel sectional	36"	Plated Steel

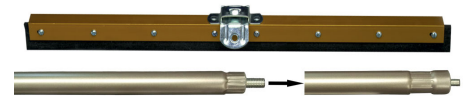
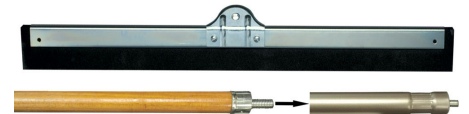

Average Duty—Neoprene Blade

Part #	Blade Material	Frame Type	Handle	Size	Frame Material
M629183	Neoprene	Straight	Steel/steel sectional	18"	Aluminum
M629248	Neoprene	Straight	Steel/steel sectional	24"	Aluminum
M627304	Neoprene	Flip flop, split blade	Wood/steel sectional	30"	Aluminum
M624364	Neoprene	Curved	Wood/steel sectional	36"	Aluminum
M629368	Neoprene	Straight	Steel/steel sectional	36"	Aluminum
		Flip flop, split blade			

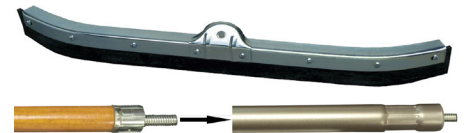

Heavy Duty—Neoprene Blade

Part #	Blade Material	Frame Type	Handle	Size	Frame Material
M602525	Neoprene	Straight, heavy duty	Wood/steel sectional	24"	Plated Steel
M602545	Neoprene	Straight, heavy duty	Wood/steel sectional	36"	Plated Steel
M623365	Neoprene	Curved, heavy duty	Wood/steel sectional	36"	Plated Steel



Speedy Corn®

Sturdy polypropylene “corn” bristles are long wearing, washable and impervious to chemicals. Will not break or shed. Bristles are heat sealed, then riveted into a metal cap. Steel band retains bristle shape.



Part #	Description	Trim	Handle	Color
Moderate Stiffness:				
M437060	Straight polypropylene	7-1/4"	Wood	Tan
M437063	Straight polypropylene	7-1/4"	Steel	Tan
M437314	Angled polypropylene	7-3/4"-9"	Wood	Tan
M437315	Angled polypropylene	7-3/4"-9"	Steel	Tan
Stiff:				
M437050	Straight polypropylene	7-1/4"	Wood	Yellow
M437053	Straight polypropylene	7-1/4"	Steel	Yellow
M437310	Angled polypropylene	7-3/4"-9"	Wood	Yellow
M437313	Angled polypropylene	7-3/4"-9"	Steel	Yellow
Extra Stiff:				
M437100	Extra stiff polypropylene	8"	Wood	Brown
M437110	Extra stiff polypropylene with chisel	8"	Wood	Brown

Upright Brooms

Wide variety of uses from warehouse and shop use to food processing and industry. Small size allows for excellent sweeping capabilities in restricted areas.

Part #	Description	Trim	Size	Use Handle	Color
M403130	Heavy duty steel back	5-1/2"	11"	M190500	Black
M403180	Average duty plastic block	5-1/2"	9"	M190700	Black
M403161	Flagged light duty with steel swivel socket	3-1/4"	9"	M190400	Grey
M403151	Average duty with steel swivel socket	3-1/4"	9"	M190400	Black

Scrub Tex® Deck Scrubs

Short trimmed, stiff-bristled scrubbing brushes come in a variety of styles from steel-backed push brooms, to plastic block with swivel handle attachments, to grit scrubs for added scrub ability.

Part #	Description	Trim	Size	Use Handle
M235140	Extra stiff polypropylene w/steel back	1-1/2"	14"	Any 3/8" stud
M335100	Stiff brown polypropylene w/wood block	2"	10"	M191100
M335210	3 surface white polypropylene w/molded block	1-3/4"	10"	Any ACME thread
M335211	3 surface blue polypropylene w/molded block	1-3/4"	10"	Any ACME thread
M335310	3 surface blue polypropylene scrub w/squeegee	1-3/4"	10"	Any ACME thread
M336100	Nylon grit deck/floor scrub w/U-joint swivel	1"	9"	Any ACME thread
M336110	Polypropylene deck/floor scrub w/U-joint swivel	1-1/4"	9"	Any ACME thread

Utility Brushes

Durable brushes for a wide variety of industrial applications.

Part #	Description	Overall (L)	Color
901661	.008 Crimped brass in hardwood block	8-7/8"	Brass
900422	.008 Crimped nylon in plastic block	8-3/8"	White
M582010	.020 Crimped polypropylene in polypropylene block	9"	White
M583010	.020 Crimped polypropylene in polypropylene block	20"	White
M572010	.020 Crimped polypropylene in foam polypropylene block	9"	Black
M573010	.020 Crimped polypropylene in foam polypropylene block	20"	Black
M582040	.020 Nylon staple set into solid polypropylene block	9"	White
M583040	.020 Nylon staple set into solid polypropylene block	20"	White
M577010	Tampico with hardwood block	9"	Black
M578010	Tampico with hardwood block	20"	Black
M576014	Polypropylene Swiss style	6"	Yellow
M576020	Nylon Swiss style	6"	White

M235140

M335100

M335210

M336100, M336110

901661

900422

M582010

M573010

M576020

Wash Brushes

Durable wash brushes with durable polypropylene brush blocks are ideal for vehicle maintenance. Brushes require flow-thru handle part #M194800 or ACME threaded handle if flow-thru handle is not needed.

Part #	Size	Brush Face	Fill Material	Trim
M492350	9-3/8" x 3-1/4"	10-1/2"	.014 Green polyester	2-1/2"
M492340	9-3/8" x 3-1/4"	10-1/2"	.012 White polystyrene	2-1/2"
M335430	10" multi level brush	11"	.012 Gray mastersweep (polyester)	2-1/2"
M335440	10" multi level brush	11"	.014 Green polyester	2-1/2"



Hygienic / Sanitary Brushes

Cleaning tools designed for use in the food industry. All components are completely hygienic.

Part #	Size	Description
M593450*	4-1/2" x 8"	Small nylon tank brush
M593460*	5-1/2" x 10"	Large nylon tank brush
M585030	3"	Nylon nail brush
M585050	6-3/4" x 2-3/4"	Flexible scrub brush
M575050	10-7/8"	Dish brush with end tuft

*Requires handle #M197300 or #M197500



M593460



M585030



M585050



M575050

Bowl Brushes

Non-scratching, long lasting brush bristles are chemical and solvent resistant.

Part #	Overall Length	Brush Diameter	Handle Material	Description
M571020	20"	5.5" x 4.5"	Plastic	Vinyl-coated non-scratch center wire with polypropylene bristles.
M571050	12.75"	4.75"	Polypropylene	White polypropylene plastic handle staple-set with white polyester fiber bristles.



Commercial Kitchen Cleaning Brushes

High temperature bristles enables cleaning of appliances even when oil is hot. Long handles for safe reach into inner surfaces. Cleans the inside, under and around a wide variety of kitchen cooking equipment. Available by special order with very high temperature material (500°F).

Part #	Overall Length	Brush Diameter	Handle Material	Fill Material	Base Wire	Brush Length	Handle Size
Straight Drain Brush - Temp max 285°:							
M593444	27-1/2"	1-1/2"	Plastic	.024 Black polyester	.125 SS*	8"	4-3/4"
90° Angled Fryer Brush - Temp max 285°:							
M593445	23-1/2"	7/8"	Plastic	.016 Natural polyester	.125 SS*	10"	4-3/4"
90° Angled Brush - Temp max 285°: extra long handle							
M593446	48"	2"	Wood	.024 Black polypropylene	.120 GS**	11"	42"

*Stainless steel, **Galvanized steel



Speedy Mop™

Constructed with plated steel components to withstand rigorous use. Sponge head is genuine cellulose. Vinyl wringer rollers squeeze dirt and water out of the sponge head. Wringer located half way up steel handle for easy wringing.

Part #	Size	Description
M660210	10"	Complete mop
M660220	12"	Complete mop
M660240	14"	Complete mop
M661210	10"	Cellulose refill
M661220	12"	Cellulose refill
M661240	14"	Cellulose refill





eMOP™

Heavy gauge aluminum shaft with high density rubber grip provides comfort and control. The wet mop’s integrated reservoir holds 24 oz. of fluid that covers up to 3,200 square feet of floor space without refilling. Adjustable nozzle allows user to control solution flow, output volume and direction. Dry mop is best used for sweeping and dusting. Use with eMOP pads below.

Part #	Overall Length	Description
M553100	60"	eMOP Bucketless Floor Cleaning System for wet mop
M553101	25"-58"	eMOP flat mop with telescoping handle for dry mop

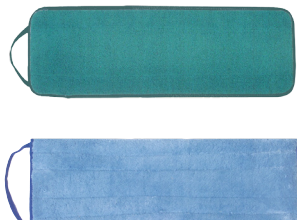

eMOP™ Pads

Microfiber pads feature a 70/30 split of polyester and nylon. Wet pads have improved soil retention as well as increased water absorption. The rolled edge of the dry pad captures dust that typically evades standard flat pad edges. The scrub pad is available for the removal of stubborn soiling from the floor surface.

Part #	Size	Description	Color
M553103	18" x 6.3"	eMOP™ wet pad	Green
M553104	18" x 6.5"	eMOP™ dry pad	Blue with rolled edges



Dust Pans

Impact-resilient plastic stays rigid but not brittle. Pan easily grips to broom or brush handles. Metal pan has a black enamel finish on heavy gage metal for rugged industrial use.

Part #	Size	Description
M445130	12"	Small plastic
M445120	18"	Jumbo plastic
M445140	12"	Small metal

Lobby Broom and Dust Pans

Free-standing dust pans with or without wheels on the back that allow for greater wearability. Lobby broom clips to dust pan for easy storage.

Part #	Size	Description
M403201	36-1/2"	6" lobby broom and metal handle combination with angled trim
M445170	12"	Lobby dust pan and handle combination on wheels
M445180	12"	Lobby dust pan and aluminum handle combination
M191115	30" x 7/8"	Replacement metal handle for part #M403201



Feather Duster

Genuine ostrich feathers attract and hold dust. Retractable plastic handle makes it quick and easy to reach difficult cleaning areas.

Part #	Fill Material	Size
M550260	Ostrich feathers	16"

Bufs

Designed for edge banding and buffing in the wood or metal finishing industries. S-shaped design allows linen materials to keep constant pressure on band while removing any excess adhesive. End result is a clean, finished and bonded edge.

Part #	Outer Diameter	Description	Inner Dia.	Brush Face (W)
PB15050	150mm	S performance buff	50mm	25mm
PB19040	190mm	S performance buff	40mm	25mm



Dressing Sheets

Aggressive material designed to true or shape both non-woven and abrasive nylon filament brushes. Silicon carbide grit removes unwanted material from surface of cylinder brushes and exposes grit contained in brush.

Part #	Size	Description	Grit
TD1524-36	15" x 24"	Black abrasive	36

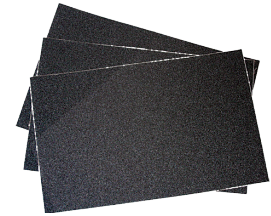

Hand Pads

Non-woven material designed for general-purpose cleaning of metal surfaces.

Part #	Size	Description	Color
MHP47	6" x 9"	General purpose	Maroon



Tufted Cylinder Brushes

Type 6.0 crimped natural nylon staple set into a high grade ABS plastic core. Low-density brush face helps reduce brush loading. Used primarily in printed circuit board industry. Other sizes available.

Part #	Outer Diameter	Overall Length	Inner Diameter
SCIS-24	3.15" (80mm)	24.43" (620.5mm)	1.475" (37.5mm)
SCIS-31	3.15" (80mm)	31" (787.5mm)	1.475" (37.5mm)

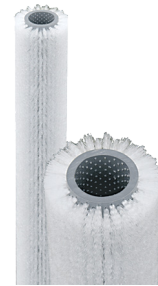

Bonded Disc Brushes

Used primarily to condition surface of printed circuit boards and other metal surfaces. Layers of non-woven discs are compressed and formed around the center of brush. Brushes are manufactured with polyurethane-bond, increasing flexibility and maximizing brush life.

Part #	Outer Diameter	Overall Length	Inner Diameter	Grit
BD27524-3	2.75" (69.9mm)	24" (609.6mm)	1" (25.4mm)	300
BD35024-3	3.5" (88.9mm)	24" (609.6mm)	1" (25.4mm)	300
BD35024-5	3.5" (88.9mm)	24" (609.6mm)	1" (25.4mm)	500
BD37524-3	3.75" (95.3mm)	24" (609.6mm)	1" (25.4mm)	300
BD37524-5	3.75" (95.3mm)	24" (609.6mm)	1" (25.4mm)	500
BD40024-3	4" (101.6mm)	24" (609.6mm)	1" (25.4mm)	300
BD40024-5	4" (101.6mm)	24" (609.6mm)	1" (25.4mm)	500
BD41224-3	4" (101.6mm)	24" (609.6mm)	1.25" (31.8mm)	300
BD41224-5	4" (101.6mm)	24" (609.6mm)	1.25" (31.8mm)	500
BD50024-3	5" (127mm)	24" (609.6mm)	1.97" (50mm)	300
BD50024-5	5" (127mm)	24" (609.6mm)	1.97" (50mm)	500
BD60024-2S	6" (152.4mm)	24" (609.6mm)	2" (50.8mm)	200



Rotary Pumice and Scrub Brushes

A round brush that can be used with scrubbing machines or flexible shafts. 5" diameter, 1" thick marine grade plywood block, and a standard 1/2" recessed arbor hole. Also used extensively for cleaning printed circuit boards.

Part #	Fill Material	Wood
500N	.014 Black level Nylon, medium stiffness	Polyurethane coated
500R	.018 Black level Nylon, stiff	Unfinished



Bonded Flap Brushes

Non-woven abrasive flaps extend outward from core of brush, yielding refined and consistent finish to printed circuit boards and metal surfaces. Bonded Flap brushes manufactured with polyurethane bond, increasing brush life and creating a flexible brush face.



Part #	Outer Diameter	Overall Length	Inner Diameter	Grit
BF37524-3	3.75" (95.3mm)	24" (609.6mm)	1" (25.4mm)	300
BF37524-5	3.75" (95.3mm)	24" (609.6mm)	1" (25.4mm)	500
BF40024-3	4" (101.6mm)	24" (609.6mm)	1" (25.4mm)	300
BF40024-5	4" (101.6mm)	24" (609.6mm)	1" (25.4mm)	500
BF41224-3	4" (101.6mm)	24" (609.6mm)	1.25" (31.8mm)	300
BF41224-5	4" (101.6mm)	24" (609.6mm)	1.25" (31.8mm)	500
BF50024-3A	5" (127mm)	24" (609.6mm)	1.97" (50mm)	300
BF50024-5D	5" (127mm)	24" (609.6mm)	1.97" (50mm)	500
BF50030-3	5" (127mm)	30" (762mm)	1.97" (50mm)	300
BF50030-5	5" (127mm)	30" (762mm)	1.97" (50mm)	500
BF60030-3S	6" (152.4mm)	30" (762mm)	2" (50.8mm)	300
BF60030-5	6" (152.4mm)	30" (762mm)	2" (50.8mm)	500

Abrasive Nylon Brushes

Heavy density and high quality abrasive nylon filament brushes. Full face configurations provide even surface scrubbing and deburring. Precision ground with diamond wheel ensuring uniform trim. Has an aluminum core and adapter.



Part #	Outer Diameter	Overall Length	Inner Diameter	Grit
PAN36224-240	3.63" (92.2mm)	24" (609.6mm)	1" (25.4mm)	240
PAN36224-320	3.63" (92.2mm)	24" (609.6mm)	1" (25.4mm)	320
PAN36224-500	3.63" (92.2mm)	24" (609.6mm)	1" (25.4mm)	500
PAN36230-240	3.63" (92.2mm)	30" (762mm)	1" (25.4mm)	240
PAN36230-320	3.63" (92.2mm)	30" (762mm)	1" (25.4mm)	320
PAN36230-500	3.63" (92.2mm)	30" (762mm)	1" (25.4mm)	500
PAN41224-240	4" (101.6mm)	24" (609.6mm)	1.25" (31.8mm)	240
PAN41224-320	4" (101.6mm)	24" (609.6mm)	1.25" (31.8mm)	320
PAN41224-500	4" (101.6mm)	24" (609.6mm)	1.25" (31.8mm)	500
PAN50024-240	5" (127mm)	24" (609.6mm)	1.97" (50mm)	240
PAN50024-320	5" (127mm)	24" (609.6mm)	1.97" (50mm)	320
PAN50024-500	5" (127mm)	24" (609.6mm)	1.97" (50mm)	500
PAN50025-240	5" (127mm)	25" (635mm)	1.97" (50mm)	240
PAN50025-320	5" (127mm)	25" (635mm)	1.97" (50mm)	320
PAN50025-500	5" (127mm)	25" (635mm)	1.97" (50mm)	500
PAN50030-240	5" (127mm)	30" (762mm)	1.97" (50mm)	240
PAN50030-320	5" (127mm)	30" (762mm)	1.97" (50mm)	320
PAN50030-500	5" (127mm)	30" (762mm)	1.97" (50mm)	500
PAN56224-240	5.63" (143mm)	24" (609.6mm)	2" (50.8mm)	240
PAN56224-320	5.63" (143mm)	24" (609.6mm)	2" (50.8mm)	320
PAN56224-500	5.63" (143mm)	24" (609.6mm)	2" (50.8mm)	500
PAN56230-240	5.63" (143mm)	30" (762mm)	2" (50.8mm)	240
PAN56230-320	5.63" (143mm)	30" (762mm)	2" (50.8mm)	320
PAN56230-500	5.63" (143mm)	30" (762mm)	2" (50.8mm)	500
PAN56324-240	5.63" (143mm)	24" (609.6mm)	3" (76.2mm)	240
PAN56324-320	5.63" (143mm)	24" (609.6mm)	3" (76.2mm)	320



Spiral Wound Coil Brushes

White type 6.0. nylon brush is used for printed circuit board industry, specifically, in I.S. Pumice Machines. Density and filament configuration of brush provides for more efficient distribution of pumice onto the board surface, maximizing brush life. Galvanized steel channel unless noted.

Part #	Outer Diameter	Overall Length	Inner Dia.	Nylon Dia.
SWC24424-N	2.5" (64mm)	24" (610mm)	.75" (19mm)	.014"
SWC31224-N	3.23" (82mm)	25" (635mm)	1.45" (37mm)	.014"
SWC31224-N12	3.23" (82mm)	25" (635mm)	1.45" (37mm)	.012"
SWC31224-NSS*	3.23" (82mm)	25" (635mm)	1.45" (37mm)	.014"
SWC31231-N	3.23" (82mm)	32" (813mm)	1.45" (37mm)	.014"
SWC31231-NSS*	3.23" (82mm)	32" (813mm)	1.45" (37mm)	.014"

*Stainless Steel Channel

FINE FINISH OIL AND WATER BASED BRUSHES

Badger

Premium quality handmade flowing brush used for water or oil base paints, urethanes, varnishes and enamels for ultra fine finishing results. Brush material is natural badger-style China bristle with a hand-formed chisel edge. Handle is pencil style, clear wood.

Part #	Size	Trim Length	Thickness	Fill Material
R10011	1"	2"	7/16"	China bristle
R10021	1-1/2"	2-1/8"	1/2"	China bristle
R10031	2"	2-1/4"	9/16"	China bristle
R10041	2-1/2"	2-5/16"	5/8"	China bristle
R10051	3"	2-5/16"	11/16"	China bristle



Onyx

Best quality provides fine all around performance for use with water or oil based paints, enamels, varnishes and urethanes. Brush material is 100% white China bristle with a chisel edge trim. Handle is clear wood.

Part #	Size	Trim Length	Thickness	Fill Material
R12013	1"	2"	7/16"	China bristle
R12023	1-1/2"	2-1/4"	1/2"	China bristle
R12033	2"	2-1/2"	9/16"	China bristle
R12043	2-1/2"	2-3/4"	5/8"	China bristle
R12053	3"	3"	11/16"	China bristle
R12063	4"	3-1/4"	11/16"	China bristle



Ace

Maintenance grade used for general applications with water or oil based paints, epoxies, resins, and sealers. Brush material is 100% black China bristle with a square trim. Handle is lacquered wood.

Part #	Size	Trim Length	Thickness	Fill Material
R12011	1"	2"	3/8"	China bristle
R12021	1-1/2"	2-1/4"	7/16"	China bristle
R12031	2"	2-1/4"	1/2"	China bristle
R12041	2-1/2"	2-1/2"	1/2"	China bristle
R12051	3"	2-1/2"	1/2"	China bristle
R12061	4"	3"	11/16"	China bristle



Matey™

Professional synthetic brush handle used for all fine finish water based paints and coatings. Beaver tail brush materials are solid tapered round polyester with a chisel edged trim. Handle is sanded wood.

Part #	Size	Trim Length	Thickness	Fill Material
R11013	1"	2-1/4"	7/16"	Polyester
R11023	1-1/2"	2-1/2"	1/2"	Polyester
R11033	2"	2-3/4"	9/16"	Polyester
R11043	2-1/2"	3"	5/8"	Polyester
R11053	3"	3-1/4"	11/16"	Polyester
R11063	4"	3-3/4"	7/8"	Polyester



Royal

Professional synthetic flat sash used for all fine finish water based paints and coatings. Brush materials are solid tapered round polyester with a chisel edged trim. Handle is sanded wood.

Part #	Size	Trim Length	Thickness	Fill Material
R11027	1-1/2"	2-1/2"	1/2"	Polyester
R11037	2"	2-3/4"	9/16"	Polyester
R11047	2-1/2"	3"	5/8"	Polyester
R11057	3"	3-1/4"	11/16"	Polyester





Queen Wood

Professional synthetic angular sash used for all fine finish water based paints and coatings. Chisel edged trim with a sanded wood handle.

Part #	Size	Trim Length	Thickness	Fill Material
R11025	1-1/2"	2-1/2"	1/2"	Polyester
R11035	2"	2-3/4"	9/16"	Polyester
R11045	2-1/2"	3"	5/8"	Polyester



Queen I

Better quality synthetic. Used for all fine water base paints and coatings in tight spaces. Chisel edged trim with a solvent resistant plastic handle.

Part #	Size	Trim Length	Thickness	Fill Material
R11014	1"	2-1/2"	1/2"	Polyester
R11024	1-1/2"	2-1/2"	1/2"	Polyester
R11034	2"	2-3/4"	5/8"	Polyester
R11044	2-1/2"	2-3/4"	5/8"	Polyester



Lark

Maintenance grade brush used for water based paints and coatings. Chisel edged trim with a solvent resistant plastic handle.

Part #	Size	Trim Length	Thickness	Fill Material
R11011	1"	2"	3/8"	Polyester
R11021	1-1/2"	2"	7/16"	Polyester
R11031	2"	2-1/4"	1/2"	Polyester
R11041	2-1/2"	2-1/4"	1/2"	Polyester
R11051	3"	2-1/2"	1/2"	Polyester
R11061	4"	3"	11/16"	Polyester



The Fooler®

Double thick disposable brush used for epoxies, resins, paints and sealers. Brush holds more coating than standard chip brush. Handle is sanded wood.

Part #	Size	Trim Length	Thickness	Fill Material
R10005	1/2"	1-3/4"	3/8"	White bristle
R10001	1"	1-3/4"	3/8"	White bristle
R10015	1-1/2"	1-3/4"	7/16"	White bristle
R10002	2"	2"	1/2"	White bristle
R10025	2-1/2"	2"	1/2"	White bristle
R10003	3"	2"	1/2"	White bristle
R10004	4"	2-1/4"	11/16"	White bristle



Economy Chip Bristle

Disposable used for epoxy, resin, paints and sealers. Handle is sanded wood.

Part #	Size	Trim Length	Thickness	Fill Material
TA605	1/2"	1-5/8"	1/4"	White bristle
PTA610	1"	1-3/4"	1/2"	Polypropylene
TA610	1"	1-3/4"	5/16"	White bristle
TA615	1-1/2"	1-3/4"	5/16"	White bristle
TA620	2"	1-3/4"	5/16"	White bristle
TA625	2-1/2"	1-3/4"	3/8"	White bristle
TA630	3"	1-3/4"	3/8"	White bristle
TA640	4"	2"	11/16" Double Thick	White bristle



Foam Brushes

Disposable used for touch-ups. Point edge trim with a peg wood handle.

Part #	Size	Trim Length	Thickness	Fill Material
R000051	1"	2"	1/2"	Black foam
R000068	2"	2-1/2"	1/2"	Black foam
R000075	3"	2-1/2"	1/2"	Black foam
R000081	4"	3"	1/2"	Black foam

Radiator

Bent wood handle is excellent for hard to reach areas. Brush material is 100% black bristle with a square trim. Handle length is 14-1/2", sanded wood.

Part #	Size	Trim	Thickness	Part #	Size	Trim	Thickness
R10013	1"	2"	7/16"		2-1/2"	2-1/2"	5/8"
R10023	1-1/2"	2-1/4"	1/2"	R10053	3"	2-3/4"	11/16"
R10033	2"	2-1/2"	9/16"	R10063	4"	3"	7/8"

Radiator, disposable

Bent ferrule disposable brush is perfect for hard to reach areas. Brush material is 100% black bristle with a square trim. Handle is sanded wood.

Part #	Size	Trim	Thickness	Part #	Size	Trim	Thickness
R10014	1"	2"	3/8"		2-1/2"	2-1/4"	1/2"
R10024	1-1/2"	2"	3/8"	R10054	3"	2-1/2"	5/8"
R10034	2"	2-1/4"	3/8"	R10064	4"	3"	11/16"

Fawn

Round sash is the right choice for trim work. Brush material is 100% black China bristle with a chisel edge trim. Handle is lacquered wood.

Part #	Size	Trim	Thickness	Part #	Size	Trim	Thickness
R15012	#2	1-5/8"	1/2"	R15042	#8	2-1/8"	1-1/8"
R15022	#4	1-7/8"	13/16"	R15052	#10	2-1/4"	1-1/4"
R15032	#6	2"	1"				

Dust Mask

Helps to breathe comfortably in dusty environments. Suitable for nontoxic nuisance dusts such as pollen.

Part #	Size
R50102	Standard, 5 per pack
R50103	Standard, 50 per pack

Coverall Paint Suit

Elastic hood, wrists, waist and ankle, two way zipper. Made of nonwoven polypropylene material that is coated with a microporous film.

Part #	Size
R50120	XXL

Polyethylene Gloves

These single use latex free polyethylene gloves are clear in color, powder free and textured inside for a secure grip, recommended for light one-time use.

Part #	Size	Packaging
RGLO1	Large (fit either hand)	500 per box

Drop Cloth - Plastic 9' x 12'

Heavy duty clear plastic 1 mm-thick layer protection.

Part #	Size
R50150	9 ft x 12 ft

Paint Mixers

Great for mixing gallon sized containers. For use with 1/4" drills or larger.

Part #	Size	Head Diameter	Shaft Length	Drill Size
R50114	Small	2-1/4"	14"	1/4"

Heavy duty power mixer can be used in containers from gallon sized to five gallon pails. For use with 3/8" drills or larger.

Part #	Size	Head Diameter	Shaft Length	Drill Size
R50115	Large	3-1/4"	17"	3/8"



Shed Resistant Microfiber Roller

Short nap—premium microfiber for use with semi-gloss and gloss paint.

Part #	Size	Nap	Surface	Core
R29822*	9"	3/8"	Smooth	Phenolic



Deluxe Mohair Roller

Short nap—premium mohair blend for use with enamels, varnishes and urethanes.

Part #	Size	Nap	Surface	Core
R23111*	3"	3/16"	Smooth	Phenolic
R24111*	4"	3/16"	Smooth	Phenolic
R29113*	9"	3/16"	Smooth	Phenolic



Multi Purpose Roller

Short nap—all purpose for use with paints, enamels, varnishes and urethanes.

Part #	Size	Nap	Surface	Core
R23114*	3"	1/4"	Smooth	Phenolic
R24114*	4"	1/4"	Smooth	Phenolic
R29114*	9"	1/4"	Smooth	Phenolic
R29014**	9"	1/4"	Smooth	Polypropylene



Foam Roller

Short nap—lint free for use with paints, enamels, varnishes and urethanes.

Part #	Size	Nap	Surface	Core
R23311*	3"	1/8"	Smooth	Phenolic
R24302*	4"	1/8"	Smooth	Phenolic
R29311*	9"	1/8"	Smooth	Phenolic



Dynex™ Roller

Medium nap—excellent for use with paints, epoxies and fiberglass resins.

Part #	Size	Nap	Surface	Core
R23123*	3"	3/8"	Smooth to semi smooth	Phenolic
R24122*	4"	3/8"	Smooth to semi smooth	Phenolic
R29123*	9"	3/8"	Smooth to semi smooth	Phenolic
R29022**	9"	3/8"	Smooth to semi smooth	Polypropylene



Treelon™ Roller

Long nap—excellent for use with flat paint.

Part #	Size	Nap	Surface	Core
R23132*	3"	1/2"	Medium to rough	Phenolic
R24132*	4"	1/2"	Medium to rough	Phenolic
R29132*	9"	1/2"	Medium to rough	Phenolic
R23133*	3"	3/4"	Medium to rough	Phenolic
R24133*	4"	3/4"	Medium to rough	Phenolic
R29133*	9"	3/4"	Medium to rough	Phenolic
R29134*	9"	1-1/4"	Medium to rough	Phenolic
R29034**	9"	1-1/4"	Medium to rough	Polypropylene



Disposable Twin Pack Roller

Disposable—for use with paint and epoxy.

Part #	Size	Nap	Surface	Core
R29301**	9"	3/8"	Smooth	Polypropylene



*Phenolic roller covers feature heat-cured pressure impregnated phenolic cores that are solvent resistant.

**Plastic roller covers feature polypropylene cores that are very solvent resistant.

SPECIALTY ROLLER COVERS AND MINI ROLLER COVERS

Fiberglass Resin Roller

For use with epoxy and fiberglass resin.

Part #	Size	Nap	Surface	Core
R29900	9"	1/8"	Smooth	Phenolic

Roof Roller (Foam)

For use on corrugated surfaces.

Part #	Size	Nap	Surface	Core
R19001	9"	N/A	Corrugated	Phenolic

Texture Roller

Use for textured finishes.

Part #	Size	Nap	Surface	Core
R29307	9"	N/A	Textured	Phenolic

4" Mini Roller Set

Includes a 4" plastic tray, 4" mini roller cover with 5/8" nap, and a 4" mini roller cover with 1/2" nap.

Part #	Size
R36054	4"

4" Mini Complete Roller

Includes a 4" mini frame and 1/2" nap mini roller.

Part #	Size	Nap
R36034	4"	1/2"

4" Mini Frame

For use with 4" or 6-1/2" nap or foam mini rollers.

Part #	Size
R36044	4"

4" Mini 1/2" Nap Roller

For use with all paints and industrial coatings. Solvent resistant.

Part #	Size	Nap	Per Package
R36026	4"	1/2"	2
R36027	4"	1/2"	10

4" Mini Foam Roller (Twin Pack)

For use with all enamel varnishes, urethanes, epoxies and paints. Solvent resistant.

Part #	Size	Nap	Per Package
R36065	4"	5/8"	2

6" Mini 1/2" Nap Roller Refill (Twin Pack)

Uses part #R36044 4" Mini Frame. For use with all paints and industrial coatings. Solvent resistant.

Part #	Size	Nap	Per Package
R36028	6"	1/2"	2

Roller Frames

Frames feature a 4-wire design or heavier duty 5-wire design.

Part #	Size	Shank Diameter	Handle Material	Thread
R33001	3"	1/4"	Plastic	Plastic
R34001	4"	1/4"	Plastic	Plastic
R39001	9"	1/4"	Plastic	Plastic
R39011*	9"	5/16"	Plastic	Plastic
R39012*	9"	5/16"	Wood	Metal

*5 wire design





4" Plastic Tray

Made from solvent resistant plastic.

Part #	Size
R35014	4"



Trays and Liners

Professional metal tray features ladder lock legs.

Part #	Size	Capacity
R35001	9"	1/2 quart
R35002	19-1/4"	2 quarts



Plastic tray featuring ladder lock legs. Solvent resistant.

Part #	Size	Capacity
R35003	9"	1/2 quart
R35004	9"	1 quart with deep well



Tray liner features a plastic insert for metal tray. Solvent resistant.

Part #	Size
R35007	9"

Tray Sets

Budget set with plastic tray, roller cover and slip-on frame.

Part #	Size
R35010	9"

Deluxe set with metal tray
Includes a 9" x 3/8" Dynex™ solvent resistant roller cover.

Part #	Size
R35009	9"

Putty Knife - Stainless Steel

Flex blade, soft comfort grip handle. For spreading putty, spackle and other materials. Also a good clean up tool for removing paint and rust.

Part #	Size
R50140	1-1/4"
R50141	3"



Paint Scraper - Soft Grip

Razor scraper – Easy push button operation with retractable locking trigger. Soft comfort grip handle. Use for removing paint, tape, stain, varnish and caulk. Caution: Store tool with blade retracted for safety.

Part #	Description
R50145	Paint scraper
R50146	Replacement blades, 10 per pack



INDEX-BRUSH PART NUMBERS

PART #	PAGE	PART #	PAGE	PART #	PAGE	PART #	PAGE	PART #	PAGE	PART #	PAGE	PART #	PAGE	PART #	PAGE
0036-00000	16	0770-06000	18	15P	7	23226	23	30081	27	4072C	22	444SSE	8	50063	28
0036-00000P	16	0770-08000	18	15PB	7	25003	30	30085	27	40725S	22	444SSP	8	50065	28
0036-00200	16	0770-10000	18	15PBL	7	25006	30	30087	27	41003	29	444T	9	50067	28
0036-00200P	16	0790-00012	17	15SS	7	25009	30	30091	27	41006	29	446266-1	31	50068	28
0036-00300	16	0790-00025	17	15SS-003	7	25012	30	30095	27	41009	29	44755	22	50071	28
0036-01000	16	0790-00037	17	15SSL	7	25015	30	30097	27	41012	29	44756	22	50073	28
0036-02000	16	0790-00050	17	15SSL-003	7	25018	30	30101	27	41015	29	44757	22	50075	28
0036-04000	16	0790-00062	17	187NAD	14	25021	30	30105	27	41018	29	44758	22	50077	28
0036-05000	16	0790-00075	17	187NP	14	25024	30	30107	27	41021	29	44759	22	50078	28
0036-08000	16	0790-01000	17	187S9X	14	25027	30	30111	27	41024	29	44765	23	50081	28
0036-10000	16	0790-01050	17	18A	4	25030	30	30115	27	41027	29	44766	23	50083	28
0037-02000	16	0865-00100	17	18B	4	25033	30	30117	27	41030	29	44767	23	50085	28
0037-04000	16	0865-00300	17	18B-012	4	25036	30	30121	27	41033	29	44768	23	50087	28
0037-05000	16	0865-01000	17	18N	4	25039	30	30125	27	41036	29	44769	23	50088	28
0037-08000	16	0865-02000	17	18SS	4	25042	30	30127	27	41039	29	44775	22	50091	28
0037-10000	16	0865-03000	17	200399	5	25045	30	30131	27	41042	29	44776	22	50093	28
01001	25	0865-04000	17	21B	5	25048	30	30135	27	41045	29	44777	22	50095	28
01002	25	0865-06000	17	21CS	5	25051	30	30137	27	41048	29	44785	23	50097	28
01003	25	0906-00000	18	21HHL	5	25054	30	30141	27	41051	29	44786	23	50098	28
01021	25	0906-00300	18	21HHLT	5	25057	30	30145	27	41054	29	44787	23	50099	28
01022	25	0906-01000	18	21KIT	5	25060	30	30147	27	41057	29	44788	23	5009	42
01023	25	0906-02000	18	21N	5	25063	30	30151	27	41060	29	44789	23	50101	28
01031	25	0906-03000	18	21N-016	5	25066	30	30155	27	41063	29	449225-3	30	50103	28
01032	25	0906-04000	18	21N-020	5	25069	30	30157	27	41066	29	449250-1	30	50105	28
01033	25	0906-05000	18	21N-020W-BLU	5	25072	30	30161	27	4148	8	449266-4	30	50107	28
01051	25	0906-06000	18	21N-020W-RED	5	25075	30	30165	27	4148006	9	449298-1	30	50108	28
01052	25	0906-07000	18	21N-020W-WHT	5	25078	30	30167	27	414CK	9	44950	28	50110	28
01053	25	0906-08000	18	21N-ESD	5	25081	30	30171	27	414CS	8	44951	22	50112	28
01071	25	0906-10000	18	21N-ESD-016	5	25084	30	30175	27	414CS006	9	44952	22	50115	28
01072	25	0906-12000	18	21N-ESD-LT	5	25087	30	30177	27	414CSC	8	44962	22	50117	28
01073	25	0907-00000	19	21NLT	5	25090	30	30181	27	414CSE	8	44963	22	50118	28
01091	25	0907-00300	19	21PB	5	25093	30	30185	27	414HH	8	44964	22	50121	28
01092	25	0907-01000	19	21SS	5	25096	30	30187	27	414N	9	468	7	50123	28
01093	25	0907-02000	19	220-2	11	25098	30	30193	27	414N-014	9	46CK	7	50125	28
01101	25	0907-03000	19	220-4	11	25099	30	30195	27	414PB	9	46HH	7	50127	28
01102	25	0907-04000	19	220-5	11	25099	30	30197	27	414PN	9	46SS	7	50128	28
01103	25	0907-05000	19	220-6	11	25099	30	30197	27	414PN	9	46SS	7	50128	28
01111	25	0907-06000	19	220-9	11	25099X	14	30B	4	414SS	8	47003	29	50131	28
01112	25	0907-08000	19	220-21	11	251993	5	30CK	4	414SSC	8	47006	29	50133	28
01113	25	0987-00025	16	221BN	5	2572D	22	30HH	4	414SS-006	8	47009	29	50135	28
01131	25	0987-00037	16	221BPN	5	2572Q	22	30KIT	4	414SS	8	47012	29	50137	28
01132	25	0987-00050	16	221CKHH	5	27001	30	30N-012	4	414SSP	8	47015	29	50138	28
01133	25	0987-00062	16	221NN	5	27002	30	30P	4	414T	9	47018	29	50141	28
01141	25	0987-00075	16	221PBN	5	27003	30	30PS	4	426K	10	47021	29	50143	28
01142	25	0987-01000	16	221SSB	5	27006	30	30T	4	426CK-ST	10	47024	29	50145	28
01143	25	0987-01050	16	221SSN	5	27009	30	321BN	5	426CS	10	47027	29	50148	28
01151	25	1CK	14	221SSSS	5	27012	30	321PBN	5	426HH	10	47030	29	50151	28
01152	25	1HH	14	22BA	6	27015	30	321SSN	5	426HH-ST	10	47036	29	50153	28
01153	25	1N	14	22CA	6	27018	30	33BA	6	426PB	10	47039	29	50155	28
01161	25	1S9	14	22GA	6	27021	30	33CA	6	426SS	10	47042	29	50157	28
01162	25	1005CK	15	22HHA	6	27024	30	33HHA	6	43003	29	47045	29	50158	28
01163	25	1005HH	15	22NA	6	27027	30	33NA	6	43006	29	47048	29	50161	28
01171	25	1005S9	15	22ND	6	27030	30	33ND	6	43009	29	47051	29	50163	28
01172	25	1005SD	15	22ND-003	6	27033	30	33ND-003	6	43012	29	47054	29	50165	28
01173	25	10072SS	23	22PA	6	27036	30	33PA	6	43015	29	47057	29	50167	28
01181	25	1010CK	15	22SA	6	27039	30	33SA	6	43018	29	47060	29	50168	28
01182	25	1010HH	15	22S9X	6	27042	30	33S9X	6	43021	29	47063	29	50171	28
01183	25	1010N	15	22SDA	6	27045	30	33SDA	6	43024	29	47066	29	50173	28
01201	25	1010S9	15	22SDX	6	27048	30	33SDX	6	43027	29	484CSC	8	50175	28
01202	25	1010SB	15	22SSA	6	27051	30	33SSA	6	43030	29	490999	26	50177	28
01203	25	1010SD	15	22SSD	6	27054	30	33SSD	6	43033	29	49101	26	50178	28
01211	25	11AL316SS	6	22TIA	6	27057	30	33TA	6	43036	29	49112	26	50181	28
01212	25	11BA	6	22TID	6	27060	30	33TIA	6	43039	29	49123	26	50183	28
01213	25	11BP	6	23105	22	27063	30	33TID	6	43042	29	49124	26	50185	28
01221	25	11BP-003	7	23106	22	27066	30	359994	9	43045	29	49148	26	50187	28
01222	25	11CKA	6	23112	22	27069	30	36B	4	43048	29	49149	26	50188	28
01223	25	11CKP	6	23113	22	27072	30	36CK	4	43051	29	49152	26	50191	28
01231	25	11HHA	6	23114	22	27075	30	36HH	4	43054	29	49153	26	50193	28
01232	25	11HHP	6	23115	22	27078	30	36N	4	43057	29	49173	26	50195	28
01233	25	11HNP	6	23116	22	27081	30	36SS	4	43060	29	49175	26	50197	28
01301	25	11ND	6	23122	22	27084	30	37SNAD	14	43063	29	49198	26	50198	28
01309	25	11ND-003	6	23123	22	27087	30	37SNP	14	43066	29	49199	26	50201	28
01321	25	11NP	6	23124	22	27090	30	37S9X	14	43112S	26	49201	26	50203	28
01325	25	11PA	6	23125	22	27093	30	40003	27	432100	26	49224	26	50205	28
01329	25	11PBP	6	23126	22	27096	30	40006	27	432101	26	49225	26	50207	28
01333	25	11S9A	6	23134	22	27098	30	40009	27	432114	26	49237	26	50208	28
01337	25	11S9X	6	23135	22	27099	30	40012	27	432126	26	49238	26	50210	28
01441	25	11SDA	6	23137	22	28A	4	40015	27	433PSC	12	49249	26	50213	28
01445	25	11SDX	6	23138	22	28B	4	40018	27	435148	26	49265	26	50215	28
01449	25	11SSA	6	23139	22	28B008	4	40021	27	435149	26	49266-4	31	50217	28
01453	25	11SSD	6	23146	22	28CK	4	40024	27	435151	26	499NAD	14	50218	28
01457	25	11SSP	7	23147	22	28CS	4	40027	27	435152	26	499NP	14	50221	28
01461	25	11SSP-003	7	23148	22	28CS008	4	40030	27	435173	26	499S9X	14	50223	28
01465	25	11TA	6	23171	22	28HH	4	40033	27	435175	26	50001	28	50225	28
01469	25	11TIA	6	23172	22	28N	4	40036	27	435200	26	50003	28	50228	28
01473	25	11TID	6	23173	22	28SS	4	40039	27	435225	2				

INDEX-BRUSH PART NUMBERS

PART #	PAGE	PART #	PAGE	PART #	PAGE	PART #	PAGE	PART #	PAGE	PART #	PAGE	PART #	PAGE	PART #	PAGE		
710312	32	86062	31	91044	26	98044	26	LBF-9NY	20	M550083	12	R10004	46	R50102	47	WA24CK	11
710318	32	86063	31	91046	26	98046	26	LBF-9PP	20	M550084	12	R10005	46	R50103	47	WA24HH	11
710324	32	86069	31	91048	26	98048	26	LBF-9SS	20	M550090	12	R10011	46	R50114	47	WA68CK	11
710512	32	86072	31	91050	26	98050	26	LBM-5HH	20	M550260	42	R10013	47	R50115	47	WA68HH	11
710518	32	86074	31	91052	26	98052	26	LBM-5NY	20	M553100	42	R10014	47	R50120	47	WA53100	11
710524	32	86076	31	91054	26	98054	26	LBM-5PP	20	M553101	42	R10015	46	R50140	50	WA7C	11
710612	32	869003	10	91056	26	98056	26	LBM-5SS	20	M553103	42	R10021	45	R50141	50	WA7HH	11
710618	32	869003N	10	91058	26	98058	26	LBM-8HH	20	M553104	42	R10023	47	R50145	50	WB10CK	11
710624	32	869904CK	10	91060	26	98060	26	LBM-8NY	20	M571020	41	R10024	47	R50146	50	WB10CN	11
710712	32	869904H	10	91062	26	98062	26	LBM-8PP	20	M571050	41	R10025	46	R50150	47	WB10HH	11
710718	32	869904HH	10	91064	26	98064	26	LBM-8SS	20	M572010	40	R10031	45	SCIS-24	43	WB10N	11
710724	32	900046	13	91066	26	98066	26	M190300	34	M573010	40	R10033	47	SCIS-31	43		
710812	32	900146	8	91068	26	98068	26	M190400	34,39	M575050	41	R10034	47	SST2B	15		
710818	32	900162	13	91070	26	98070	26	M190500	34,40	M576014	40	R10041	45	SST6B	15		
710824	32	900183	11	91072	26	98072	26	M190600	34	M576020	40	R10043	47	SST10B	15		
711012	32	900183ESD	010.11	91074	26	98074	26	M190700	34,40	M577010	40	R10044	47	SST12B	15		
711018	32	900183ESD-016.11	11	9162CK	10	AB4	13	M190900	34	M578010	40	R10051	45	SST2CK	15		
711024	32	900183L	11	9162HH	10	AB4N	13	M191000	34	M578340	31	R10053	47	SST6CK	15		
711212	32	900183T	11	9162N	10	AB5	13	M191100	34	M578350	31	R10054	47	SST10CK	15		
711218	32	900183TL	11	95000	26	AB5N	13	M191115	42	M582010	40	R10063	47	SST12CK	15		
711224	32	900422	40	95005	26	AB8	13	M191200	34	M582040	40	R10064	47	SST2G	15		
720712	32	900431	13	95006	26	AL251HH	14	M191200	34	M583010	40	R11011	46	SST6G	15		
720718	32	900437	11	95008	26	AL251N	14	M191400	34	M583040	40	R11013	45	SST10G	15		
720724	32	900437ESD-010.11	11	95010	26	AL437N	14	M194800	34	M585030	41	R11014	46	SST12G	15		
720812	32	900437ESD-016.11	11	95012	26	BD27524-3	43	M195615	34	M585050	41	R11021	46	SST2HH	15		
720818	32	900437T	11	95014	26	BD55024-3	43	M197300	34	M593450	41	R11023	45	SST6HH	15		
720824	32	900488	21	95016	26	BD55024-5	43	M197500	34	M593460	41	R11024	46	SST7HH	15		
721012	32	900488GH	21	95018	26	BD37524-3	43	M197511	34	M593444	41	R11025	46	SST10HH	15		
721018	32	900488N	21	95020	26	BD37524-5	43	M217240	35	M593445	41	R11027	45	SST12HH	15		
721024	32	900488SD	21	95022	26	BD40024-3	43	M230180	35	M593446	41	R11031	46	SST2N	15		
721212	32	900488T	21	95024	26	BD40024-5	43	M230240	35	M602510	38	R11033	45	SST6N	15		
721218	32	900492CK	10	95026	26	BD41224-3	43	M230360	35	M602520	38	R11034	46	SST7N	15		
721224	32	900492HH	10	95028	26	BD41224-5	43	M231180	35	M602525	39	R11035	46	SST10N	15		
721512	32	900504	9	95029	26	BD50024-3	43	M231183	37	M602530	38	R11037	45	SST12N	15		
721518	32	900565-2.5	33	95032	26	BD50024-5	43	M231240	35	M602540	38	R11041	46	SST2P	15		
721524	32	900565-2.5BT	33	95034	26	BD60024-2S	43	M231243	37	M602545	39	R11043	45	SST6P	15		
721812	32	900565-3.5	33	95036	26	BF37524-3	44	M231360	35	M602590	38	R11044	46	SST10P	15		
721818	32	900565-3.5BT	33	95038	26	BF37524-5	44	M232180	35	M602610	38	R11045	46	SST12P	15		
721824	32	900565-4	33	95040	26	BF40024-3	44	M232183	37	M602620	38	R11047	45	SST2PP	15		
722012	32	900565-4BT	33	95042	26	BF40024-5	44	M232240	35	M602660	38	R11051	46	SST6PP	15		
722018	32	900565-5	33	95044	26	BF41224-3	44	M232243	37	M623240	38	R11053	45	SST10PP	15		
722024	32	900565-5BT	33	95046	26	BF41224-5	44	M232360	35	M623300	38	R11057	45	SST12PP	15		
722512	32	900565-6.5	33	95048	26	BF50024-3A	44	M232363	37	M623360	38	R11061	46	SST2S9	15		
722518	32	900565-6.5BT	33	95050	26	BF50024-5D	44	M233180	35	M623365	39	R11063	45	SST6S9	15		
722524	32	900622	12	95052	26	BF50030-3	44	M233240	35	M624364	39	R12011	45	SST10S9	15		
730712	32	900674-6	33	95054	26	BF50030-5	44	M233360	35	M625182	38	R12013	45	SST12S9	15		
730718	32	900674-6BT	33	95056	26	BF60030-3S	44	M235140	40	M625183	39	R12021	45	SST2S5	15		
730724	32	900674-7	33	95058	26	BF60030-5	44	M236180	35	M625242	38	R12023	45	SST6S5	15		
731012	32	900674-7BT	33	95060	26	BT146HH	14	M236183	37	M625243	39	R12031	45	SST10S5	15		
731018	32	900674-8	33	95062	26	BT146N	14	M236240	35	M625300	38	R12033	45	SST12S5	15		
731024	32	900674-8BT	33	95064	26	BT201B	14	M236243	37	M625303	39	R12041	45	SST2T	15		
731212	32	900674-9	33	95066	26	BT201HH	14	M236360	35	M625360	38	R12044	45	SST6T	15		
731218	32	900674-9BT	33	95068	26	BT201N	14	M236363	37	M625363	39	R12051	45	SST10T	15		
731224	32	900674-10BT	33	95070	26	BT202B	14	M331813	36	M627304	39	R12053	45	SST12T	15		
731512	32	900744	13	95072	26	BT202G	14	M331814	36	M628180	38	R12061	45	SST6TEF	15		
731518	32	900982	20	95074	26	BT202N	14	M331815	36	M628240	38	R12063	45	SST10TEF	15		
731524	32	900982DN	20	97002	26	BT203G	14	M331816	36	M629180	38	R15012	47	SST12TEF	15		
731712	32	900982SDN	20	97004	26	BT203N	14	M331823	36	M629183	39	R15022	47	SWC24424-N	44		
731718	32	900997-A	33	97005	26	BT204HH	14	M331824	36	M629240	38	R15032	47	SWC31224-N	44		
731724	32	900997-2.5	33	97008	26	BT204N	14	M331825	36	M629248	39	R15042	47	SWC31224-N12	44		
732012	32	900997-3.5	33	97010	26	BT406SS	14	M331826	36	M629368	39	R15052	47	SWC31224-NSS	44		
732018	32	900997-4.5	33	97015	26	BT407SS	14	M332413	36	M645160	38	R19001	49	SWC31231-N	44		
732024	32	900997-5.5	33	97016	26	BT606SS	14	M332414	36	M645240	38	R23111	48	SWC31231-NSS	44		
732512	32	901336-010BR	21	97017	26	BT706N	14	M332415	36	M649180	38	R23114	48	TA605	46		
732518	32	901336-010SS	21	97018	26	BT706SS	14	M332416	36	M649240	38	R23123	48	TA610	46		
732524	32	901336-016PK	21	97020	26	BTL-BEL-1	20	M332423	36	M660210	41	R23132	48	TA615	46		
733012	32	901336-016SD	21	97022	26	CDFP	12	M332424	36	M660220	41	R23133	48	TA620	46		
733018	32	901350-016SD	21	97024	26	CDHH	12	M332425	36	M660240	41	R23311	48	TA625	46		
733024	32	901661	40	97026	26	CDHH	12	M332426	36	M661210	41	R24111	48	TA630	46		
740524	32	901724	33	97028	26	DBT	12	M332426	36	M661220	41	R24114	48	TA640	46		
740536	32	901724-5	33	97030	26	D8T	13	M333214	36	M661240	41	R24122	48	TCB-0	25		
740548	32	901735	35	97032	26	EB14 S56	21	M333215	36	M925490	38	R24132	48	TCB-1/2	25		
740724	32	901735H	35	97034	26	EB14HH	21	M333216	36	M925491	38	R24133	48	TCB-1/4	25		
740736	32	901744PK	21	97036	26	EB14P	21	M333223	36	MHP47	43	R24302	48	TCB-2	25		
740748	32	901744PP	21	97038	26	EB14SD	21	M333224	36	PAN36224-240	44	R29014	48	TCB-10	25		
741024	32	901820	33	97040	26	EB14T	21	M333225	36	PAN36224-320	44	R29022	48	TCB-3/4	25		
741036	32	901820L	33	97042	26	EB14TT	21	M333226	36	PAN36224-500	44	R29034	48	TCB-3/8	25		
741048	32	902984	8	97044	26	FTC-16	20	M335100	40	PAN36230-240	44	R29113	48	TCB-4	25		



ABOUT GORDON BRUSH®

Since 1951, Gordon Brush has been recognized worldwide as a leading manufacturer of quality industrial brushes. We offer over 15,000 brushes—and can modify or custom manufacture any brush to meet your unique specifications. All of our brushes are designed, manufactured and shipped from our state-of-the-art, 183,000 square-foot facility in the City of Industry. This ensures that your order meets our stringent quality standards each and every time.

Our turnaround times set us apart from the rest of the industry. As a U.S.-based manufacturer, we can offer same-day shipping on over 2,000 standard items. And we can deliver custom quotes at lightning speed—usually in one business day or less. Whether you need a standard brush or a custom solution, you can always count on Gordon Brush for bigger, better brush ideas.



Gordon Brush Mfg. Co., Inc.
3737 Capitol Ave., City of Industry, CA 90601 USA
ph: 1-800-950-7950 or 323-724-7777
FAX: 323-724-1111
email: sales@gordonbrush.com
www.gordonbrush.com

